



UWP 3.0 HW manual

rev. 0.7, 06/09/2018

UWP 3.0 SYSTEM DESCRIPTION AND INSTALLATION MANUAL

This manual is an integral part of the smart-building system. Please read it carefully, as it contains important information regarding safety.

- The smart-building system must be used only for the usage it has been designed for. Every other kind of usage is potentially unsafe. The manufacturer is not responsible for improper usage.
- The manufacturer is not responsible for the consequences of using non-original spare parts.
- This manual is subject to change without notice.

Index

1 SYSTEM DESCRIPTION	5
1.1 The master unit: UWP 3.0	6
1.1.1 UWP 3.0 bus description	8
1.1.2 RS485 and MODBUS/RTU	10
1.1.2.1 Abstract	10
1.1.2.2 UWP 3.0 as a Modbus Master	10
1.1.2.3 UWP 3.0 as a Modbus Slave	10
1.1.2.4 How to connect energy meters	10
1.1.3 BACnet	11
1.1.4 Modbus/TCP	11
1.1.4.1 Abstract	11
1.1.4.2 UWP 3.0 as a Modbus/TCP Master	11
1.1.4.3 UWP 3.0 as a Modbus/TCP Slave	11
1.2 Managing additional field-buses: the bus generator concept	12
1.2.1 Wiring the high speed bus	15
1.3 The Dupline® bus	16
1.3.1. How to extend the Dupline ® bus	18
1.3.1.1 Network design	18
1.3.1.2 Repeater wiring	19
1.3.1.3 Isolator feature	21
1.3.1.4 Placing the SB2REP230 in a project	21
1.3.2 Dupline: cable and installation tips	24
1.3.2.1 New Installation Planning	24
1.3.2.2 Retrofit Installation using existing cables	25
1.3.2.3 Cable Routing	25
1.3.2.4 Cable Splices and Connections	25
1.3.3 How to define the number of Dupline® networks	28
1.3.4 Dupline® bus in the cabinet	30
1.4 The wireless bus WiDup	33
1.5 How to connect the Mobile modem	33
1.5.1 How to connect the USB Dongle Connection Module SH2DSP24	34
1.6 Ethernet connection	36
1.7 Micro SD	37
1.8 USB stick installation	38
1.9 How to size the Carlo Gavazzi DC power supply	39
1.9.1 How to calculate the needed power	39
1.9.2 How to wire the power supply	40
2 INSTALLING THE BUILDING AUTOMATION SYSTEM	41
3 APPENDIX “A” – RS485 NETWORK GUIDELINES	42
3.1 MODBUS via Serial line (RS-485) guidelines	42
3.1.1 Introduction	42

3.1.2 RS-485 cable	42
3.1.3 RS-485 grounding	42
3.1.4 RS-485 shielding	42
3.1.5 RS-485 termination	42
3.1.6 RS-485 wiring procedure	42
3.1.7 RS-485 topology	43
4 APPENDIX B - SAFETY RECOMMENDATIONS	44

1 System description

UWP 3.0 is a monitoring gateway and controller that allows to monitor and control installations where Energy Efficiency Management, Building Automation and Car Park Guidance functions are needed. The system monitors and controls connected devices via its local bus management functions; it includes a web server with a powerful and intuitive user interface to display custom dashboards and interact with local devices and remote systems; the UWP 3.0 embedded automation server allows to exchange data locally or remotely via standard Internet protocols. UWP 3.0 can manage the complete lighting control system based on DALI actuators and it can operate as a BACnet/IP gateway.

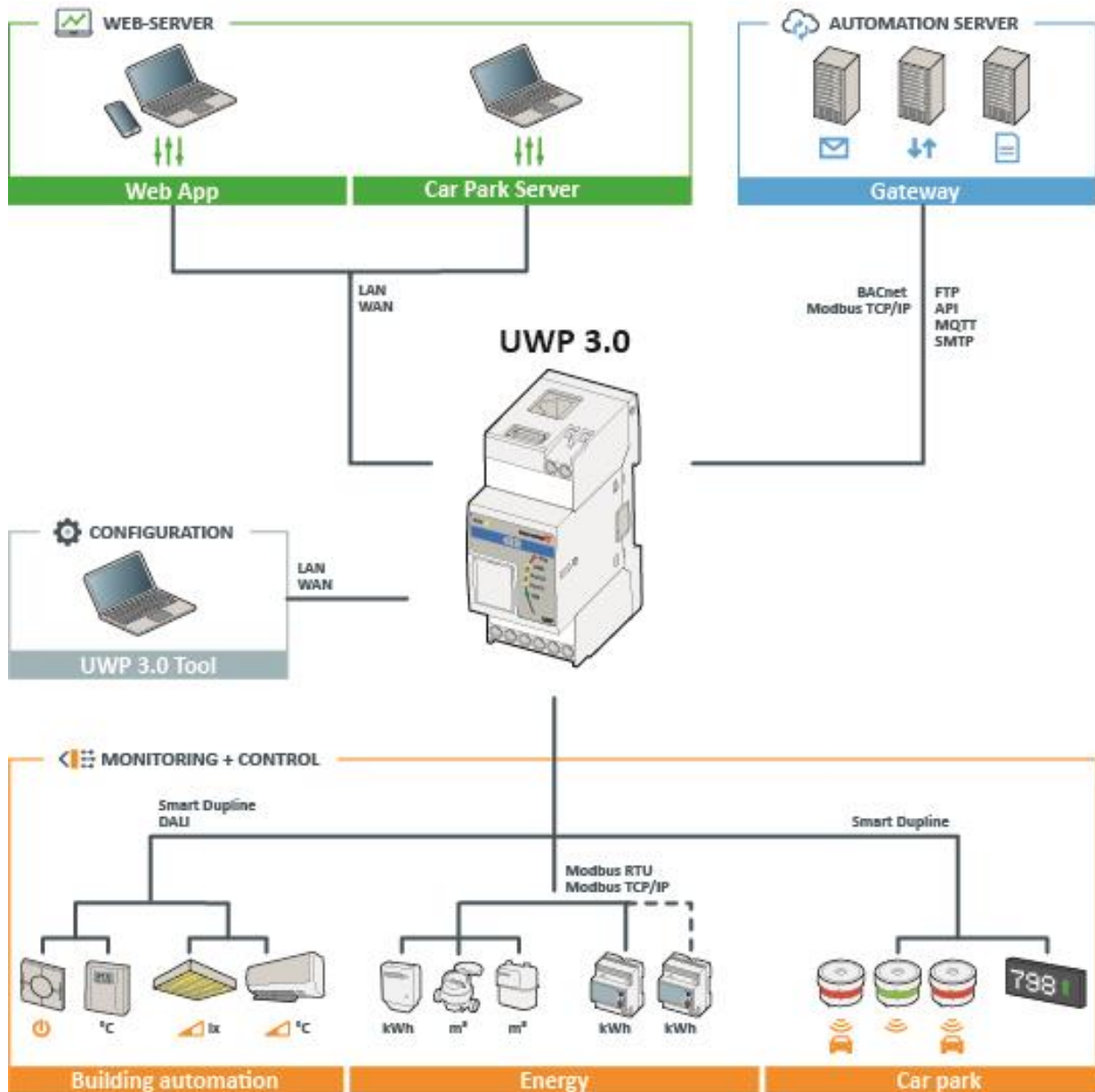

1.1 The master unit: UWP 3.0

The system is based on UWP 3.0, a Linux based embedded PC that embeds datalogger, gateway, controller and web-server functions in a small 2DIN unit. The Ethernet port allows both local and remote communication via a wide range of protocols; the data logger can record any value/event coming from the field buses. Meters, sensors and actuators can be connected and configured for putting in place the necessary mix of monitoring and control functions.

Here below a diagram of the system is shown.

System

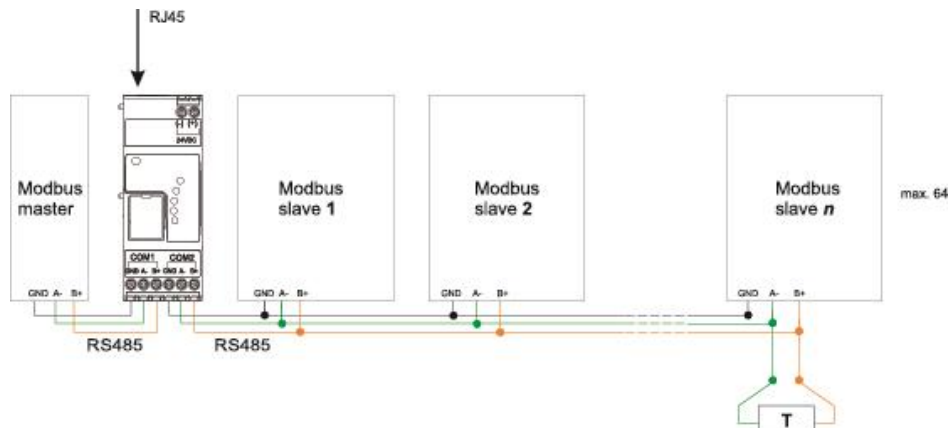

Modbus RTU connection. COM 1 slave, COM 2 master

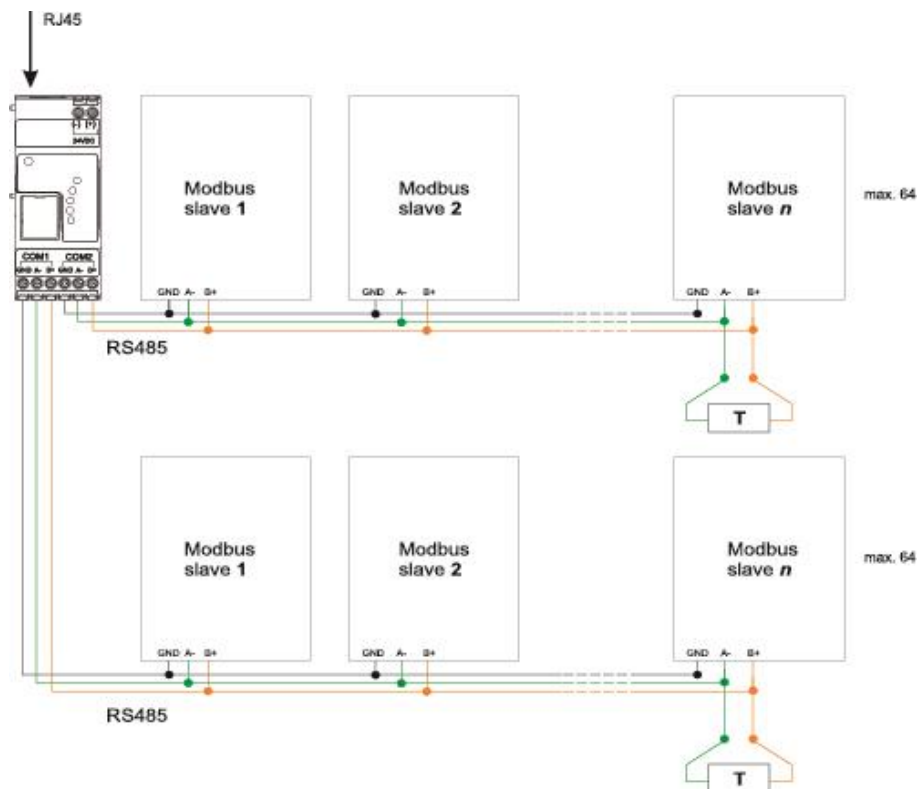

Modbus RTU connection. COM 1 master, COM 2 master

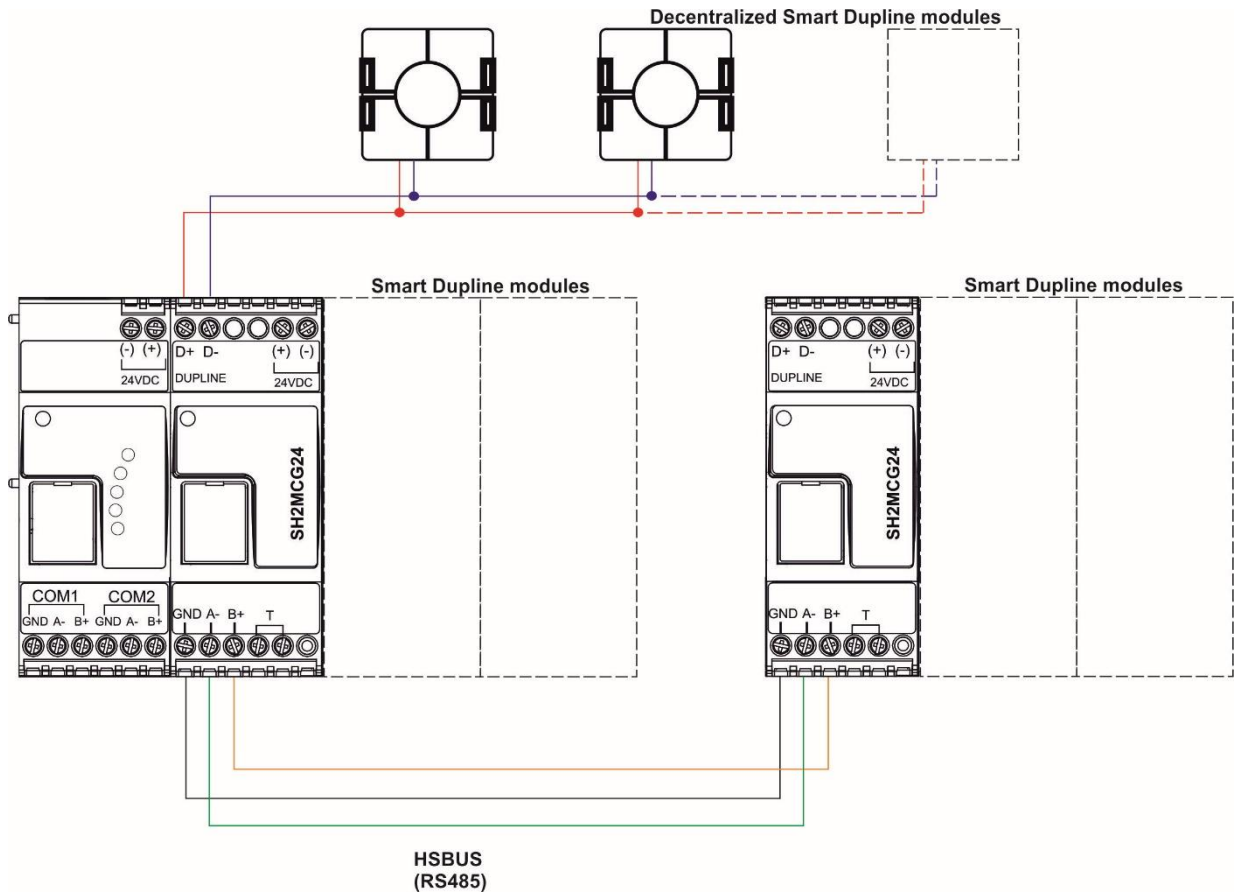

Example of Smart Dupline modules connection using master channel generators

Hardware

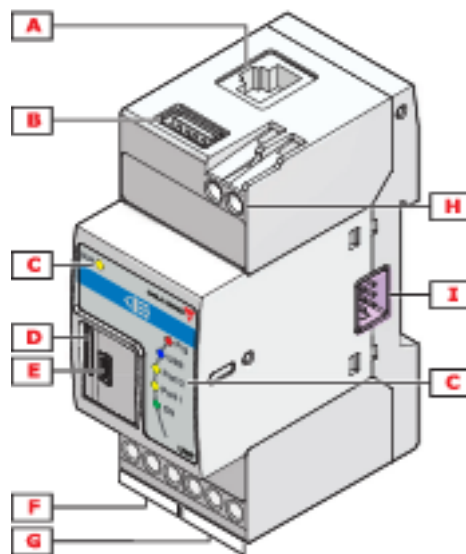

The following table provides a summary of the hardware characteristics of the product:

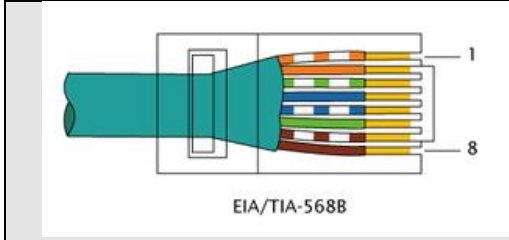
Ports and connections	<p>1 X 15 to 30Vdc power supply (A1+ and A2-) 2 X RS-485 (COM1 and COM2) :</p> <table border="1" style="margin-left: 40px;"> <tr> <td rowspan="3" style="background-color: #e0e0e0;">COM1</td> <td>Data – (A-)</td> </tr> <tr> <td>Data + (B+)</td> </tr> <tr> <td>GND</td> </tr> <tr> <td rowspan="3" style="background-color: #e0e0e0;">COM2</td> <td>Data – (A-)</td> </tr> <tr> <td>Data + (B+)</td> </tr> <tr> <td>GND</td> </tr> </table> <p>1 X RJ-45 connector for 10/100 Base-T Ethernet [Communication]</p> <div style="display: flex; align-items: center;">  <table border="1" style="margin-left: 20px;"> <tr> <td>Pin 1 TX+</td> </tr> <tr> <td>Pin 2 TX-</td> </tr> <tr> <td>Pin 3 Rx+</td> </tr> <tr> <td>Pin 6 Rx-</td> </tr> </table> </div> <p>1 X standard USB 1 X mini USB connection 1 X slot for micro SD or SDHC memory card</p>	COM1	Data – (A-)	Data + (B+)	GND	COM2	Data – (A-)	Data + (B+)	GND	Pin 1 TX+	Pin 2 TX-	Pin 3 Rx+	Pin 6 Rx-
COM1	Data – (A-)												
	Data + (B+)												
	GND												
COM2	Data – (A-)												
	Data + (B+)												
	GND												
Pin 1 TX+													
Pin 2 TX-													
Pin 3 Rx+													
Pin 6 Rx-													
Absorption	5W Max.												
Operating conditions	-25°C to 40°C												
COM port termination	Both COM ports are internally terminated with a value of 150Ω and polarized with two 511Ω resistors (from “B+” to +5V and from “A-“ to GND). As a consequence, no other external connection is required from the UWP 3.0 side (see Appendix A for the other termination).												

1.1.1 UWP 3.0 bus description

Local bus 1: This is placed in the connector on the right side and it is called the High-Speed bus. This bus is used to connect the bus generators to the **UWP 3.0**.

Local bus 2: This is placed in the connector on the left side and it is a USB bus used to connect to the USB dongle connection module SH2DSP24.

(*) The SH2UMMF124 is no longer available.

RS485 port 1: This is a serial port used to connect to other third-party serial devices.

RS485 port 2: This is a serial port with Modbus master capability used to connect to Carlo Gavazzi energy meters.

USB port: This is placed on the top of the housing and it can be used to change the IP address.

SD-card: It can be only used to change the IP address.

Ethernet port: This is placed on the top of the housing and has to be used to connect to the UWP 3.0 tool.

The available connections can be summarized as shown below.

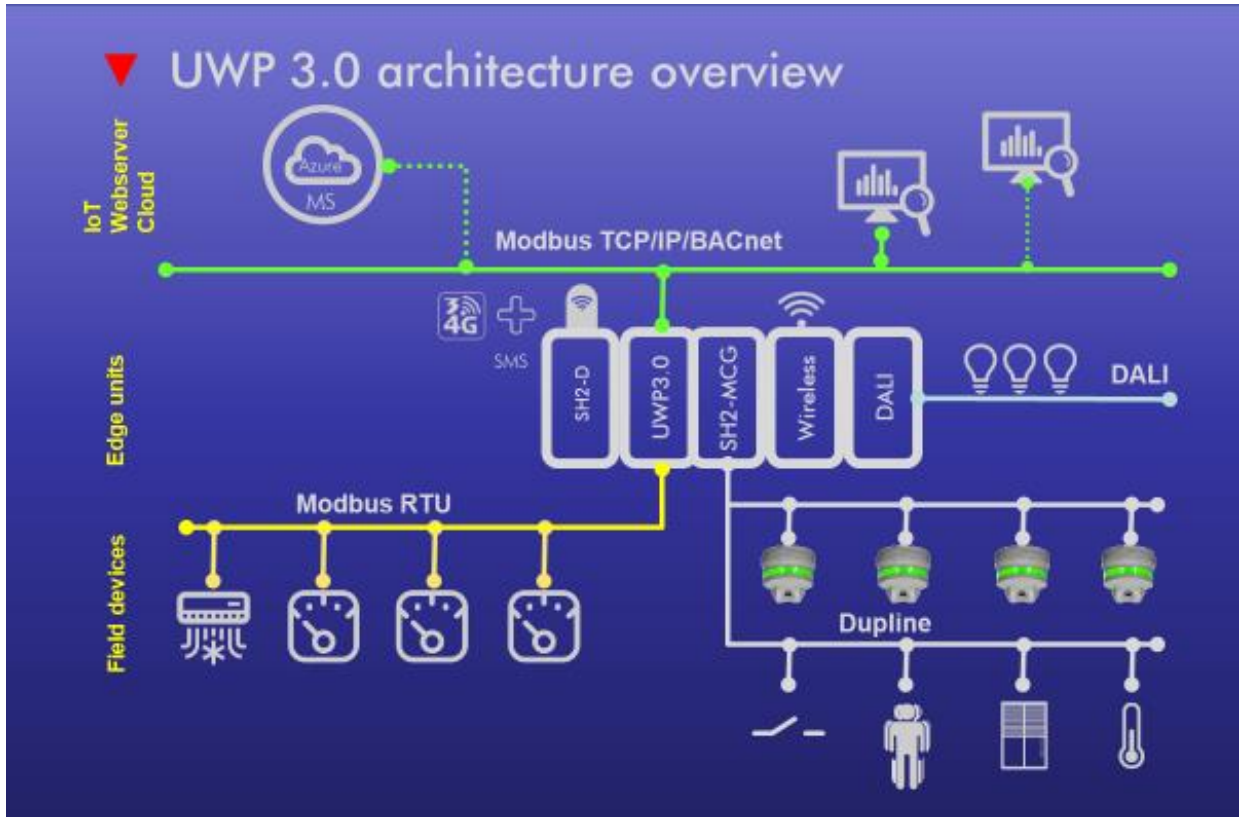

N.B.: All the connections described in the following paragraphs must be carried out without power supply.

1.1.2 RS485 and MODBUS/RTU

1.1.2.1 Abstract

UWP 3.0 has 2 RS485 ports. COM port 2 of the **UWP 3.0** is an RS-485 port with Modbus master capability. COM port 1 can be configured as Modbus master or Modbus slave.

1.1.2.2 UWP 3.0 as a Modbus Master

Any Modbus/RTU device can be connected to COM1 or COM2, thanks to the Modbus Editor Tool (MDE), a software package part of the UWP 3.0 Tool which allows users to encapsulate any Modbus protocol into an UWP 3.0's driver. It is also possible to send Modbus commands to a Modbus slave, thanks to the specific feature of UWP 3.0.

1.1.2.3 UWP 3.0 as a Modbus Slave

COM1 may be configured as a Modbus slave port. In this case, by using the UWP 3.0 tool, it is possible to map the desired Modbus registers from the connected devices or functions to a MODBUS/RTU map.

Note: please check the UWP 3.0 Tool manual for a detailed explanation.

1.1.2.4 How to connect energy meters

UWP 3.0 works as a Modbus master for any Modbus device.

Very often it is necessary to connect Modbus energy meters, so to log their data and make them available to the database, the web-server or the automation server processes. Modbus drivers for connecting Carlo Gavazzi meters are embedded in the UWP 3.0 tool. To connect other energy meters from other brands, the Modbus Driver Editor allows a quick and easy set-up and testing of the desired driver.

The number of energy meters which can be connected to a UWP 3.0 depends on the network conditions, the number of datapoints, the CPU load conditions of the UWP 3.0.

According to the bare RS485 limits, up to 128 energy meters can be connected to one UWP 3.0:

- Up to 64 can be connected to COM2 port;
- Up to 64 can be connected to COM1 **only** if it is configured as Modbus master;

the specific figure depends on the parameters mentioned above and could change from installation to installation:

An example of the connection between an energy meter and the **UWP 3.0** is shown below:

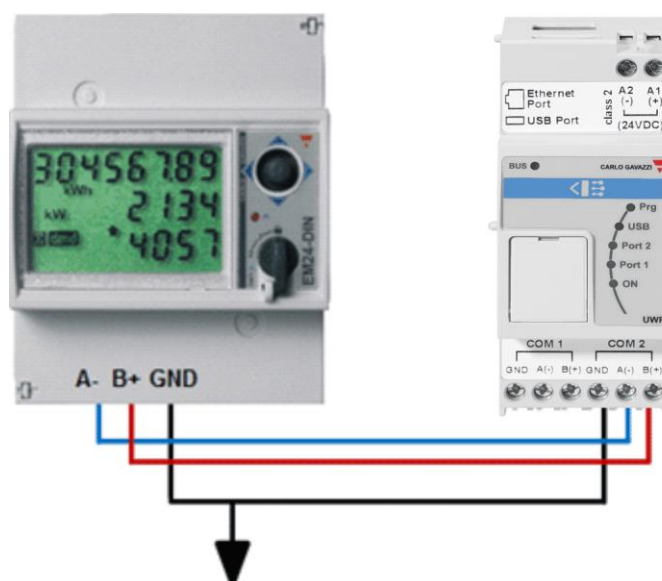

Different models and brands of energy meters can be mixed, and they can also have different baud rate (see the **UWP 3.0 Tool** software manual for more details about how to configure the **UWP 3.0** to manage them).

N.B. The energy meters should be configured and connected to the load as described in the relevant instruction manuals. No configuration nor discovery can be carried out using the UWP 3.0 Tool software.

For more details about the wiring of the RS-485, please refer to appendix A.

1.1.3 BACnet

UWP 3.0 can work as a BACnet server, making available whatever set of variables to external BACnet clients or BMS systems; please check the **UWP 3.0** tool manual for further details.

1.1.4 Modbus/TCP

1.1.4.1 Abstract

UWP 3.0 has an Ethernet port by which it is possible to connect both Modbus/TCP slaves and Modbus/TCP masters at the same time.

1.1.4.2 UWP 3.0 as a Modbus/TCP Master

Any Modbus/TCP device can be connected to **UWP 3.0**, thanks to the MODBUS Editor Tool (MDE) a software package part of the **UWP 3.0** Tool which allows to encapsulate any Modbus protocol into an **UWP 3.0** driver. It is also possible to send Modbus commands to a Modbus slave, thanks to the specific feature of **UWP 3.0**.

1.1.4.3 UWP 3.0 as a Modbus/TCP Slave

The Ethernet port can also be set-up to work as a Modbus/TCP slave port. In this case, by using the **UWP 3.0** tool, it is possible to map the desired Modbus registers from the connected devices or functions to a Modbus/TCP map.

Please check the **UWP 3.0** tool manual for further details.

1.2 Managing additional field-buses: the bus generator concept

The **UWP 3.0** is the brain of the energy management system but it cannot work alone and it needs the necessary bus connections to interact with the real world. In the case of Dupline® bus, specific bus generators are needed to send commands to the slave modules and collect information from them. They are connected to the **UWP 3.0** via the high-speed bus that is present both on the local bus and on the terminals at the bottom of the bus generators. This means that the connection is very fast and easy in a cabinet, since the modules only have to be plugged together, without any wiring, and at the same time it is very straightforward if the bus generators have to be mounted in different cabinets. Up to 7 bus generators can be connected to one **UWP 3.0**.

Any combination of the available bus generators (Smart Dupline, Wireless Dupline...) is possible.

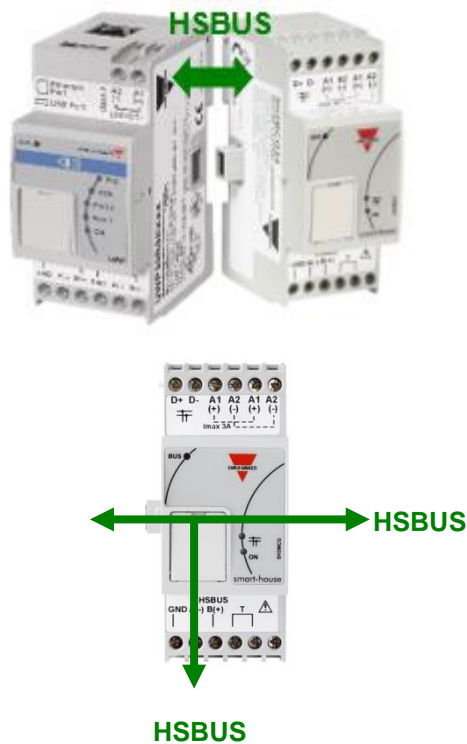

Example 1: The bus generators are all connected in the same Din-rail.

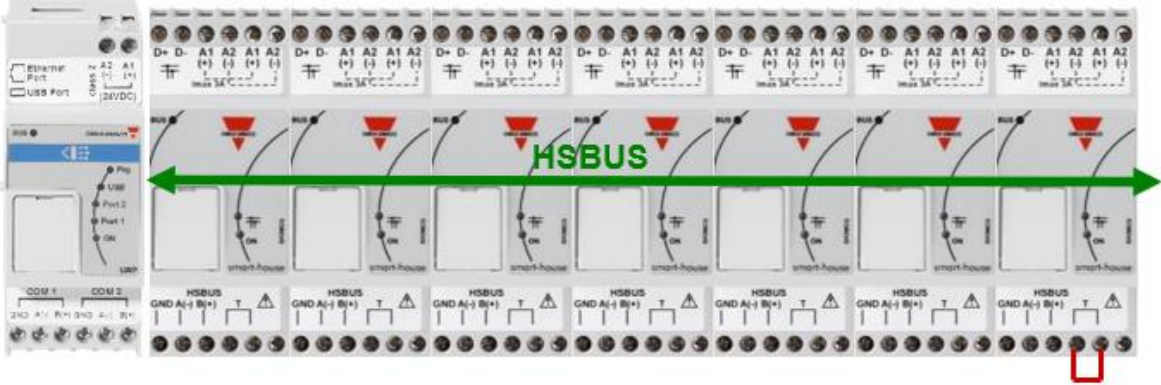

Example 2: The bus generators are mounted in different cabinets.

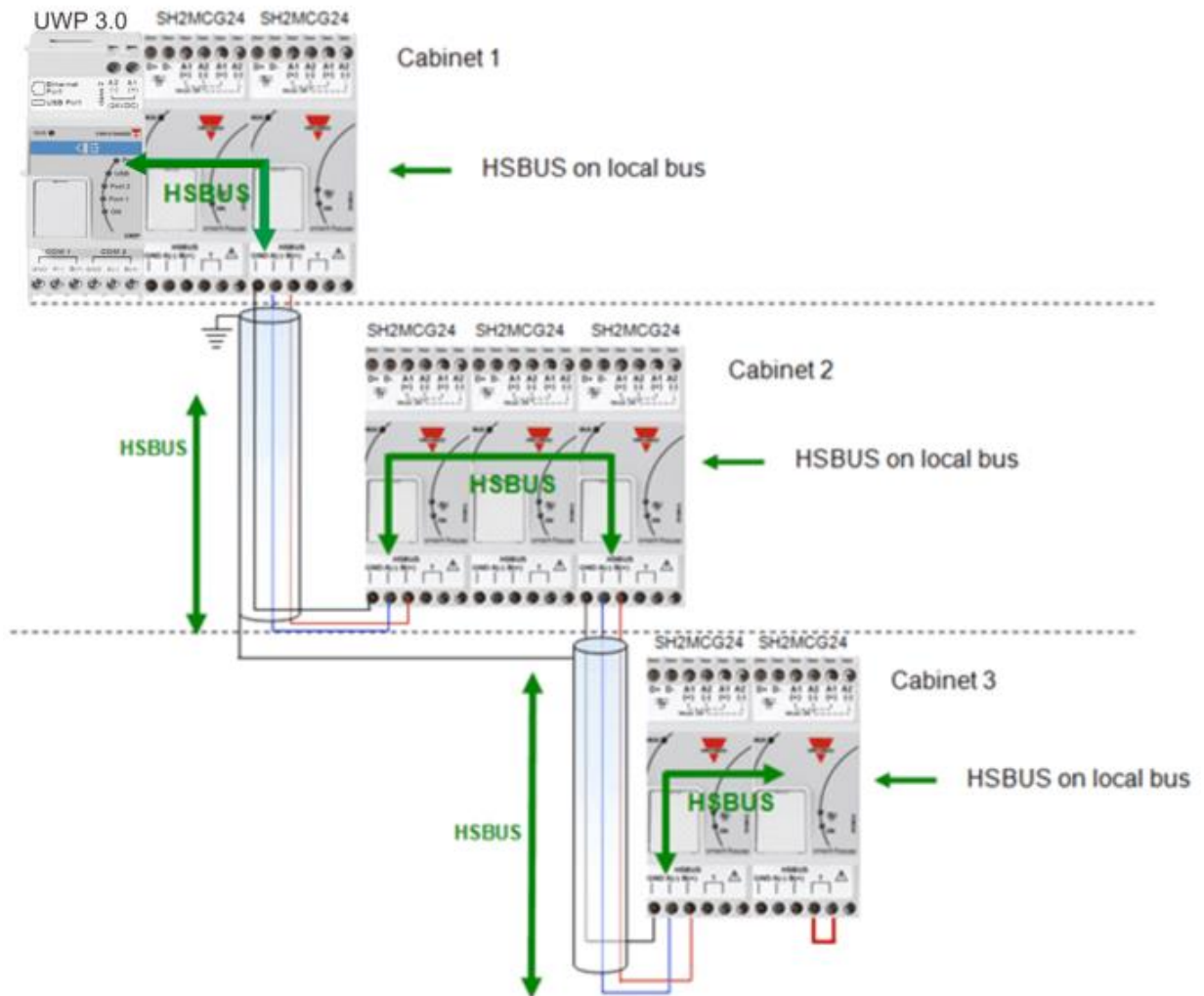

Example 3: The bus generators for UWP 3.0 do not need to be put all together in a DIN rail, and they can be mixed with the Dupline® modules as is shown in the picture below.



Also in this case there is no need to wire the RS485 for the HS speed bus since the local bus connector of the Dupline® modules is transparent to it. The installer only has to terminate the HS speed bus in the last bus generator of the RS485 network.

1.2.1 Wiring the high speed bus

The high speed bus is a Carlo Gavazzi proprietary implementation of an RS485 serial interface, at 256Kbit/s

The cable

The RS485 communication cable is a shielded, twisted pair cable. Many cable manufacturers supply cable meeting the RS485 standard. Other cabling, such as telephone cable, coaxial cable and multi-core wires should not be used as they could prove problematic and not provide satisfactory performance. Cables must be at least 0.5 mm.

Topology

The cable must be installed to pass close by each node. Stubs (cables joining the node to the cable), stars (multiple cable segments brought back to a single point) or loops must not be used.

Cable length

The maximum length of the cable is 600 metres.

Connection of the cable shield

The shield of the RS485 cable establishes a reference voltage for the RS485 signal conductors.

The "screen pig-tails" going into the terminals should be as short as possible. The shield should be continuous throughout the installation, the best way is to connect the shield to earth ground in only one point as nearest as possible to the **bus generator** (the best is on the terminal where the cable is connected). This connection is not to be shared with other devices which could add external noise or disturbance.

Termination

The network must be terminated at the end on the last bus generator of the network (see the T terminals in the picture above) while it has already been terminated on the **bus generator** side. This is to avoid reflections which would disrupt communication.

Cable Insulation

The communication cable must not be run in cable trays carrying power wiring nor in close proximity to power wiring. Current surges in power wiring due to high equipment starting currents or to faults can disrupt communication.

For more details please see appendix A.

1.3 The Dupline® bus

The Dupline® bus is a signal transmission system that reduces the need for wires, as compared with standard buses. Using only 2 wires, the information can be transmitted from up to 2 km away. Many input and output modules are supplied from the same 2 wires. Both digital (on-off) and analogue (e.g. temperature, light level, wind speed and other) data is present on the bus at the same time ; all signals are processed by the **UWP 3.0**.

The **SH2MCG24** is the smart Dupline® bus generator that powers the Dupline® bus onto the local bus and onto the terminals at the top. All the Dupline® slave modules have to be connected to one **UWP 3.0** to be part of the building automation system.

The **SH2MCG24** is powered by 15 to 30Vdc.

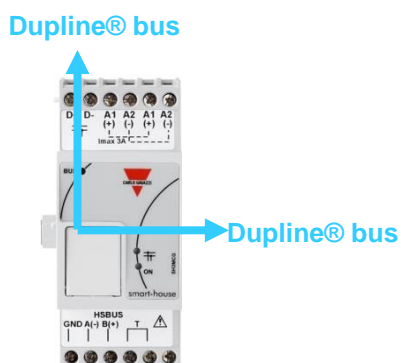

The Dupline® modules in the building automation system can be divided into two groups:

- Decentralized modules: these are all the modules such as light switches, PIR sensors, lux sensors, decentralized I/O modules, etc. which are mounted into the wall boxes or on the wall
- Centralized cabinet modules: these are the ones housed in the 1-DIN or 2-DIN housing for din rail mounting

All our **decentralised** Dupline® devices are connected to each other with a single 2-wire cable. This cable carries the communication signal that comes from the bus generator **UWP 3.0**. These 2 wires carry a DC low-voltage pulsating signal, and therefore attention must be paid to keep the correct polarity of the connection.

The Bus is overload and short-circuit protected, but anyway it is a good rule to avoid to invert the polarity.

The modules cannot withstand voltages other than the Dupline® signal voltage (5.5V to 10V).

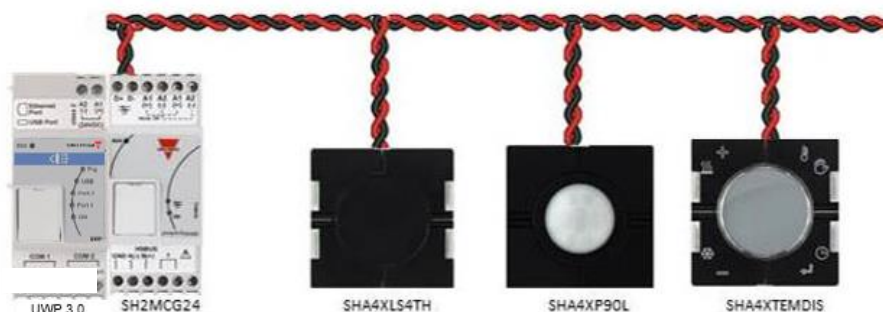

The so-called *decentralised* modules can be divided into the following groups:

- Light switches
- PIR sensors
- Temperature displays
- Water and smoke detectors
- Wind sensors
- Humidity sensors
- Light sensors
- Decentralised input/output modules

The installation is not to be engineered around the Dupline® bus because it can be matched to the application. The routing of the cable may be in a line, star, ring or any combination.

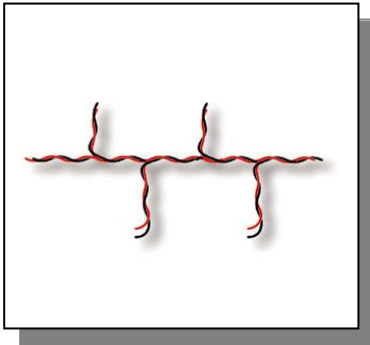

Straight-through: the best place for the SH2MCG24 would be in the middle of the line

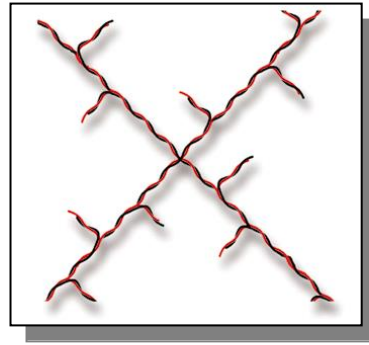

Star: the best place for the SH2MCG24 would be in the middle of the star

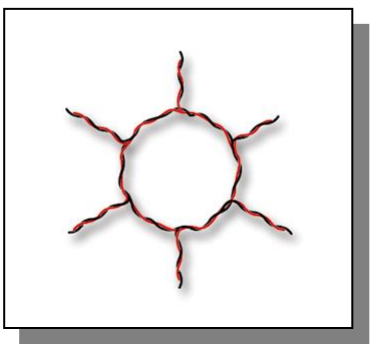

Ring: the best location for the SH2MCG24 is in the middle between the two farthest distant modules.

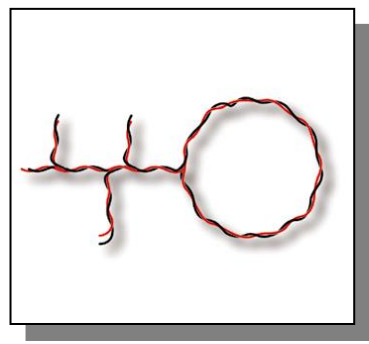

Combined: the best location for the SH2MCG24 is in the middle between the two farthest distant modules.

1.3.1. How to extend the Dupline® bus

1.3.1.1 Network design

Sometimes, in new or in existing installations, there is the need to extend the length of the Dupline® network beyond the typical Dupline® operative distance. At the same time, it could be necessary to place some modules at the end of the Dupline® network where a balanced distribution of the modules is not possible: the cable resistance and load from bus-powered modules result in an excess voltage drop and might cause the modules placed far from the Dupline® generator not to work properly.

The SB2REP230 module is a 115 to 230 VAC-powered Dupline® repeater and isolator and is the ideal solution to overcome the problems described above. It also allows the network design to be simplified and it can be connected to any point on the Dupline® bus.

The picture below shows a simplified wiring diagram between the Dupline® repeater and the Dupline® generator:

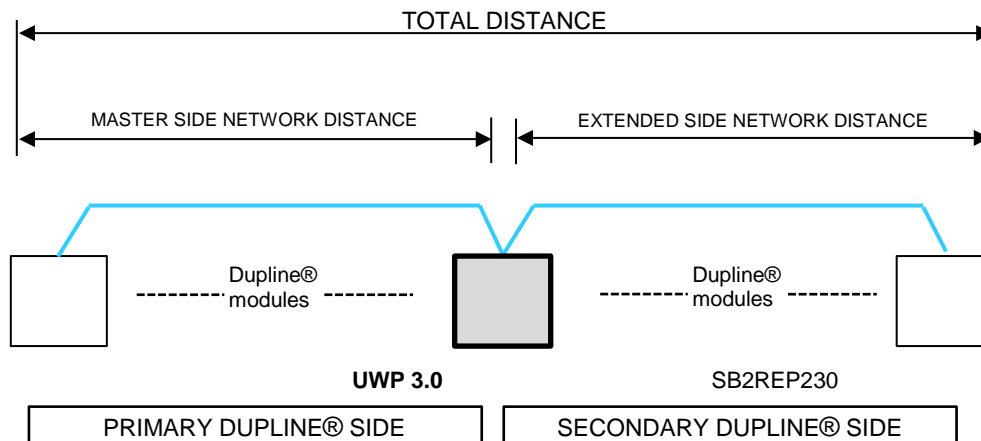

1.3.1.2 Repeater wiring

The repeater regenerates the voltage level of the Dupline® signal from the bus generator and also provides an output drive capability of up to 300mA. Since most of the Dupline slave modules are bus-powered, the SB2REP230 provides the bus power supply to the modules connected to it.

Example 1:

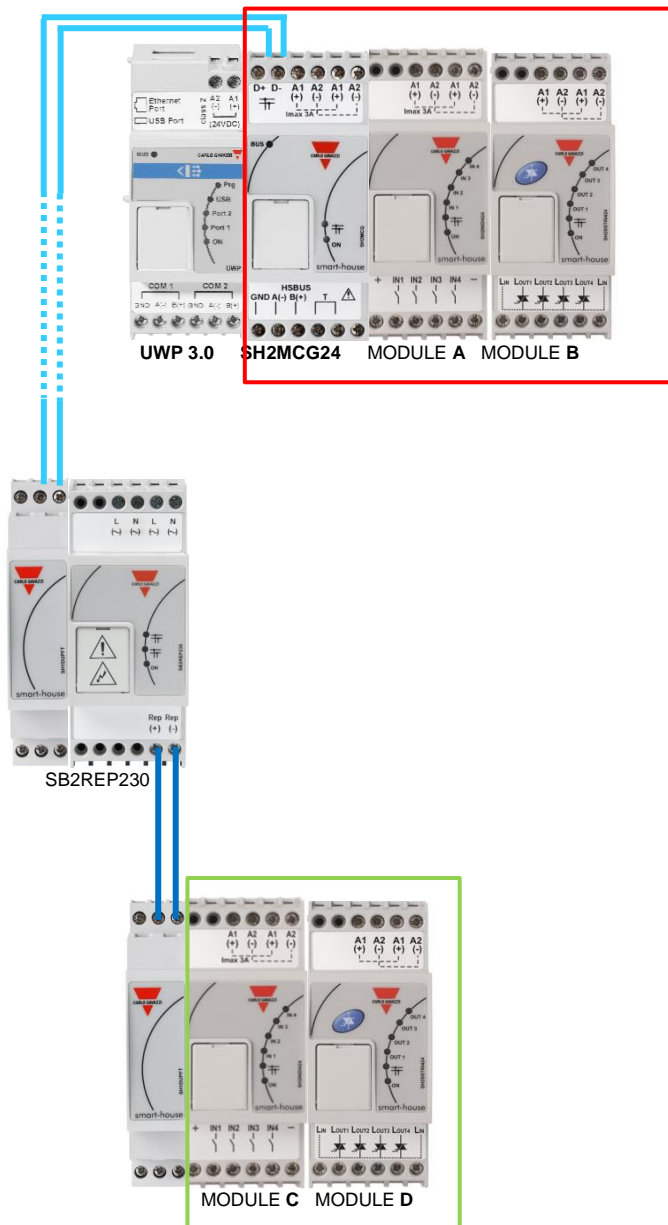

Note: the local bus on both sides is connected to the primary side of the Dupline network, so the secondary side has always to be connected to the terminals REP+ and REP-

Dupline current for Modules **A** and **B** are provided by the Dupline® generator

Dupline current for Modules **C** and **D** are provided by the Dupline® repeater

How to install an UWP 3.0 system

The Dupline® repeater does not create any new Dupline® network: all the Dupline® slave modules connected to the SB2REP230 are part of the same network generated by the **SH2MCG24** which the repeater is connected to.

Example 2: The example below shows the network topology

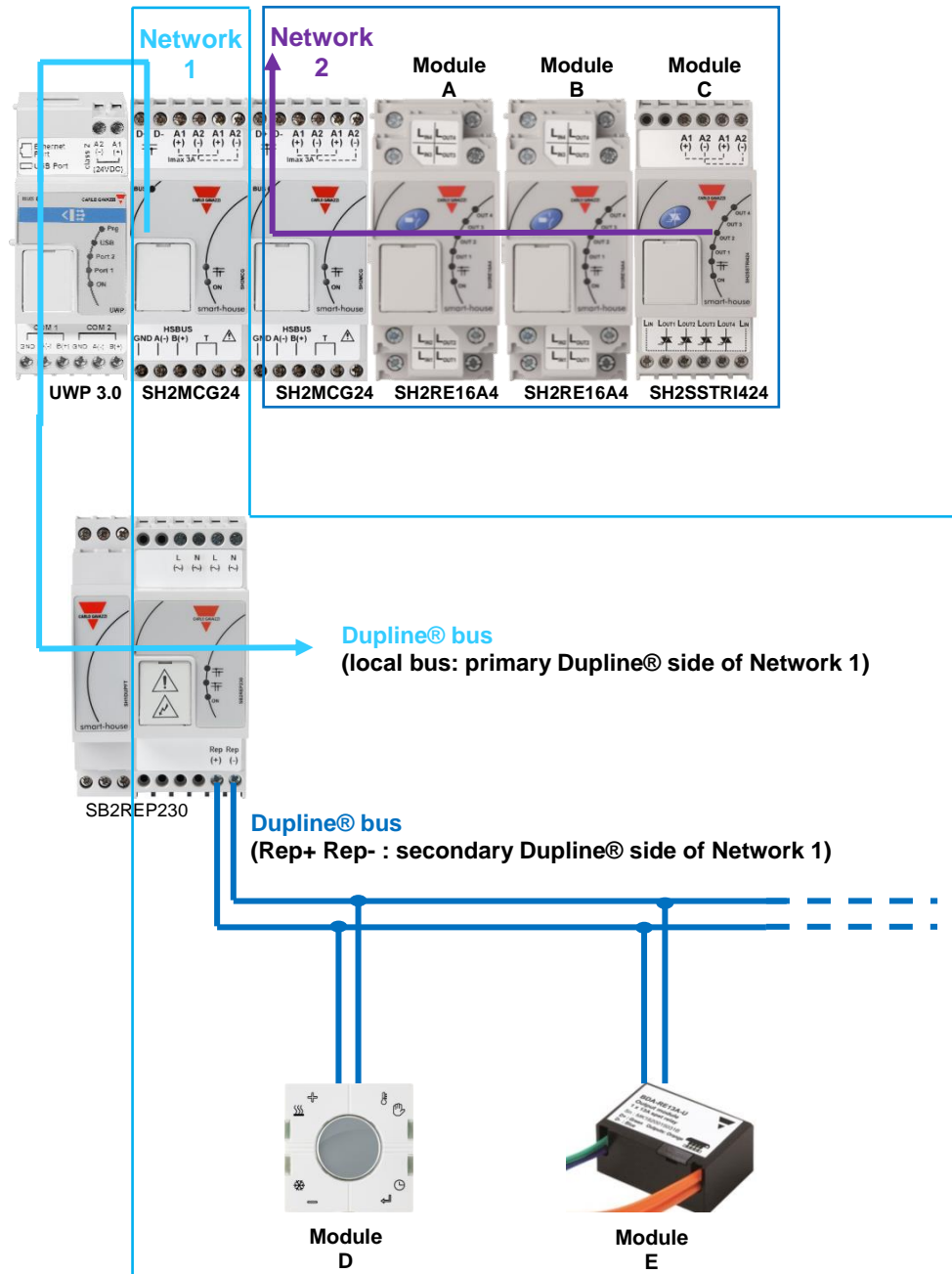

Modules **D** and **E** are part of the **Dupline® network 1**

Modules **A**, **B** and **C** are part of the **Dupline® network 2**

1.3.1.3 Isolator feature

In addition, the isolator feature contributes to the separation of the sides of the bus for maximum safety. The primary and secondary Dupline® signals are isolated, which means the primary side, made up of the modules connected to the Dupline® generator, will continue to operate in the case of a short circuit on the secondary side, made up of the modules connected to the Dupline® repeater.

As shown in the example below, the modules connected to the Dupline generator (shown in the green box) will continue to operate in the case of a short circuit on the secondary side (shown in the red box)

Example 3:

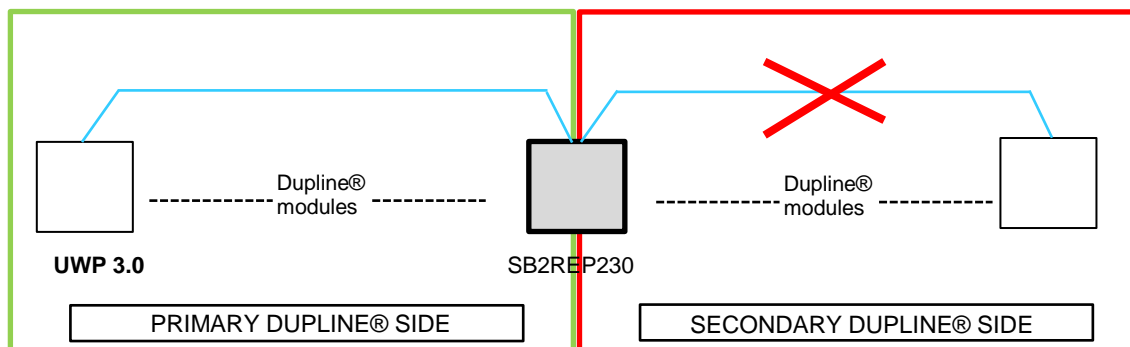

As soon as the short circuit is removed, the secondary side will automatically become operational again.

N.B. In the case of a short circuit on the primary Dupline® side, the secondary Dupline® also goes down: until the short circuit is removed (see above), neither of the Dupline sides will operate.

1.3.1.4 Placing the SB2REP230 in a project

To wire a Dupline repeater into a network, the Dupline transparent module SH1DUPFT has to be used: the terminals on the top of the **SH2MCG24** are connected to the Transparent module and the Dupline repeater just has to be plugged into the local bus connector. The Dupline® repeater is typically mounted in a different cabinet some distance from the **SH2MCG24**.

The secondary side has to be connected to the terminals REP+ and REP- (see pictures on pages 18 and 19).

The Dupline repeater is able to regenerate the bus voltage starting from a minimum value of 5.5V: care must be taken to connect it before the voltage drops to below this minimum voltage.

Recommendation:

On each bus branch it is not possible to connect more than one repeater in series: the connection shown in the picture below must be avoided.

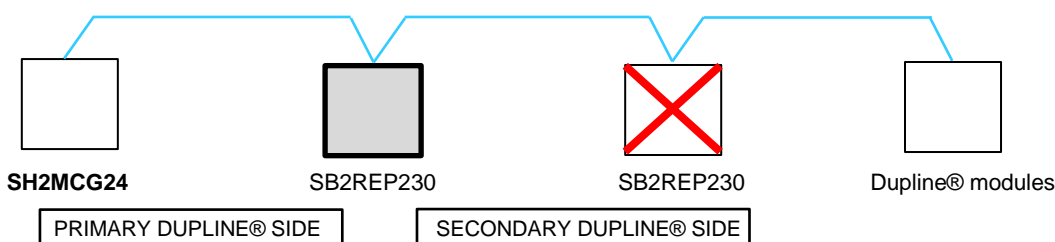

Example of correct wiring:

The example below shows a correct network design, where the installer has placed the Dupline® DIN-rail modules in different cabinets and the distances have been calculated by considering the cable section and the voltage drop due to the bus-powered connected modules.

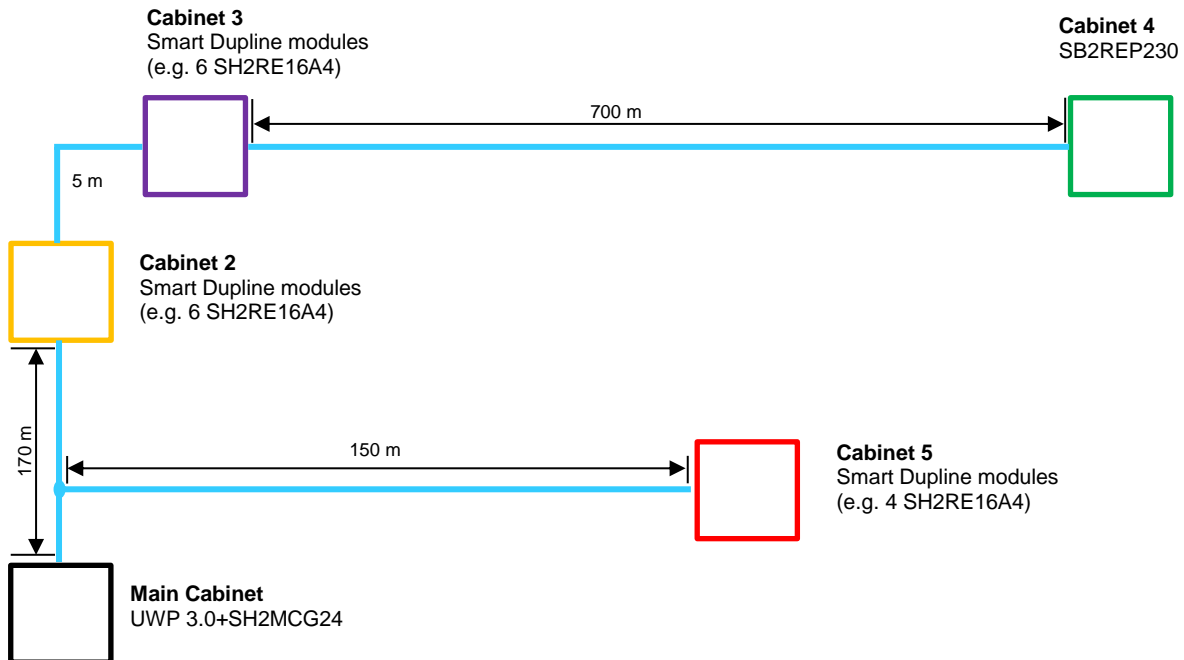

In the main cabinet, shown by the black square in the picture above, the installer has placed the **UWP 3.0** and the **SH2MCG24**.

The other cabinets are shown in colours:

- the red one is 150 metres from the **UWP 3.0**: the repeater is not necessary because of the short distance and the small load connected
- the yellow cabinet is next to the purple one and they are 170 metres away from the Dupline generator. Here the installer has placed 6 Din-rail modules (SH2RE16A4), which do not generate too high a voltage drop since, in normal conditions, the consumption of the 4 relay modules supplied by the bus is 6mA (even if this value increases when a relay is switched on/off)
- in the purple cabinet, the installer has placed another 6 SH2RE16A4 modules
- the green cabinet is 700 metres away from the violet cabinet and the repeater is placed here to boost the current and voltage, which otherwise are not sufficient to supply the other relay modules placed here.

Example of Dupline Bus current calculation (see the voltage-drop file)

To calculate the voltage drop at the end of the 700m, as shown in the green cabinet in the picture above, the installer has to use the **excel file**, available in our Product Selection website, in the **UWP 3.0** and **SH2MCG24** pages.

The data used to calculate the voltage drop in the example above is:

- Cable section: 0.75 mm;
- Number of modules in the yellow and violet cabinets: 12
- Consumption of a SH2RE16A4: 6mA
- Total consumption of the network: about 72 mA
- Voltage measured at the end of the 700m: 5.5V

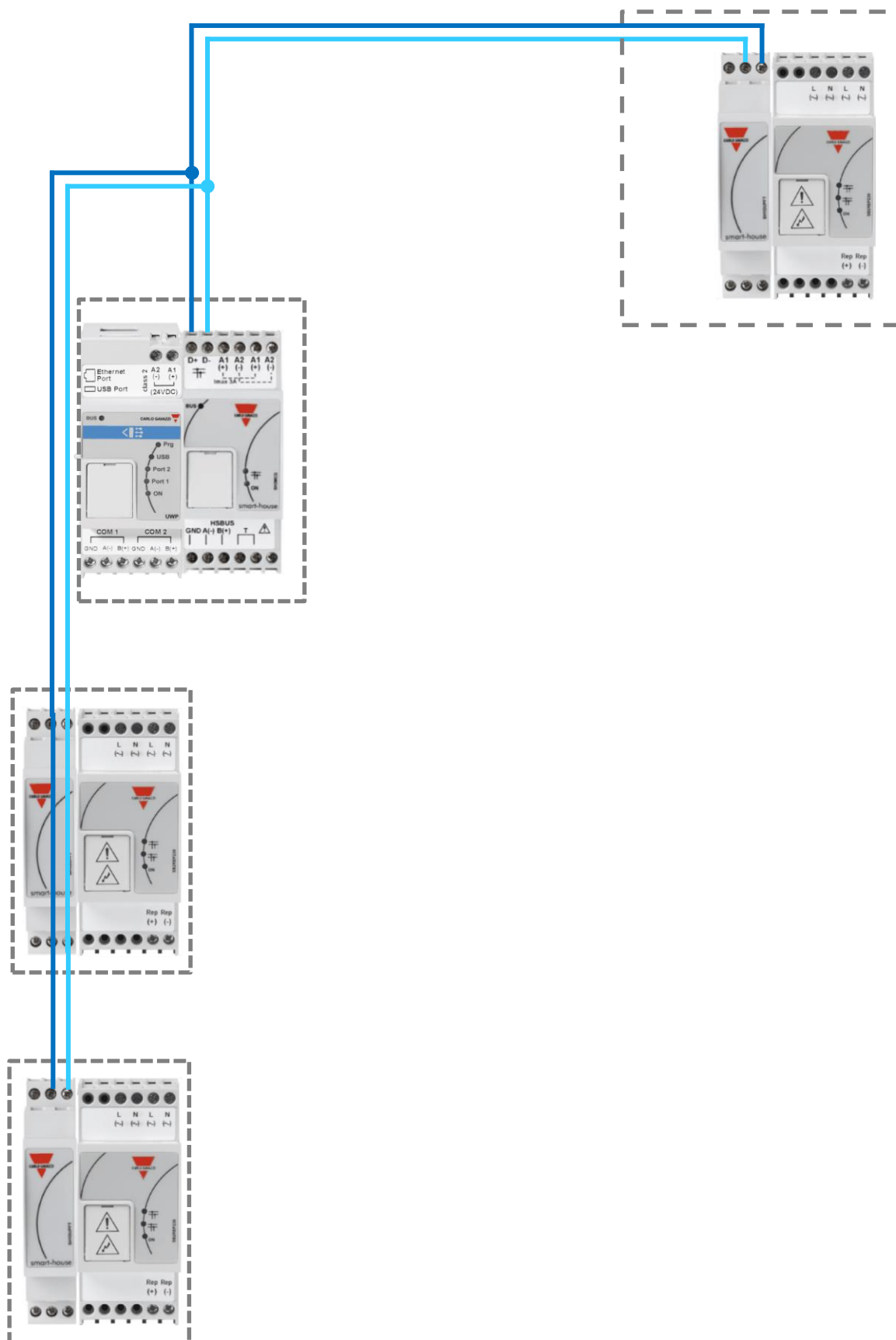

1.3.2 Dupline: cable and installation tips

1.3.2.1 New Installation Planning

When planning a new installation, a generic Bus cable can be used: it is better to use a twisted cable in order to prevent electrical noise from affecting one conductor more than the other and thereby creating an unbalanced Dupline® system.

In the case of very noisy installations (with noise sources such as contactors, inductive loads etc) we recommend the use of a shielded cable.

The table below can be used to find the right cable: this can easily be carried out by considering the maximum distance between the **SH2MCG24** and the farthest module in the installation and checking the table below.

The values shown in the table have been calculated considering a balanced distribution of the modules in the Dupline® bus.

Installations where most of the modules are placed at the end of the network may be critical and this is not recommended (the table is not valid in this case).

The values shown in the table are also suitable for installations where the majority of the modules are placed at the beginning of the network (close to the **SH2MCG24**); this type of connection represents the best configuration to guarantee the best performance of the system.

Table of cable sections:

Max current Consumption	Cable size		
	0.75 mm ² (AWG 19), twisted	1 mm ² (AWG 17), twisted	1.5 mm ² (AWG 15), twisted
450 mA	50 m	70 m	100 m
350 mA	65 m	90 m	130 m
300 mA	75 m	100 m	150 m
250 mA	90 m	120 m	180 m
200 mA	115 m	150 m	230 m
150 mA	150 m	200 m	300 m
100 mA	225 m	300 m	450 m
50 mA	450 m	600 m	900 m

The user is recommended to select cables according to the length and consumption shown in the table above. It is also advisable to use polyethylene conductor insulation to have lower cable capacitance.

The total consumption of all the modules supplied by the Dupline® bus (e.g. light switch, PIR, lux sensors) and the cable resistance affect the voltage of the Dupline® bus.

The drop in the Bus voltage might cause the modules placed far from the **SH2MCG24** not to work correctly.

1.3.2.2 Retrofit Installation using existing cables

If the installation uses existing cables, it is important to verify the cross section of conductors according to the above cable section table.

Once the cable size is checked, it is important to ensure that there is no leakage between the two conductors and, also, no leakage from the conductors to ground or shield.

The best method of leakage testing before connecting any Dupline® modules is to use an insulation tester (min. 500 V) to verify a resistance higher than 100.000 kΩ.

1.3.2.3 Cable Routing

The Dupline® cable is a signal cable and it should, therefore, be routed as such. This means that it is better to keep it separate from power cables, high energy noise sources such as contactors, switched inductive loads etc. However, if there are no other alternative possibilities, the routing of Dupline® cable may pass close to power cables. Should the power cables be very noisy, we suggest using shielded cables.

1.3.2.4 Cable Splices and Connections

Cable splices are often the source of problems.

It is strongly recommended to splice only cables of the same characteristics (wire cross section, capacitance, etc). The splicing contact resistance must be as low as possible. Twisted wire splicing under a wire nut or terminal strip can deteriorate over a certain period of time. It is, therefore, advisable to use soldering splices. For shielded cable the shield must be continued, but it must not be grounded at the splicing points. Splices need to be water-tight to prevent the entry of water into the cable, which could result in increased capacitance.

Note: Bad splices and/or splices left uncovered, exposed to humid environments, could create critical problems difficult to route.

During the installation of each module, the length of external cables (input/output) must be selected according to the datasheet reference.

These wires must be treated as signal wires and be kept away from contactors, relays, motors and other inductive noise sources. In extreme cases it is necessary to use shielded cable. But here the shield must also be properly grounded at one point only.

With the high flexibility of Dupline®, external input and output wires should, of course, be kept as short as possible by bringing the Dupline® bus to the points where signals are to be transmitted or received.

Note: For the dimmer module the cable between the cabinet module and the light should not exceed 25 metres.

Note: For input modules with contact inputs, the short circuit current (indicated on the individual datasheets) must be noted and adequate switching devices must be selected for trouble-free operation.

Note: if multi-conductor cable is used, where some of the conductors are spare, we highly recommend connecting all spare wires to ground (preferably close to the **SH2MCG24**). This to reduce the "antenna effect" of open-end wires.

Recommendations:

- 1) Do not connect any of the wires to other voltage potentials.
- 2) Do not connect any of the wires to protective earth (PE).
- 3) Do not parallel any wires to increase the square of the cores.
- 4) Do not use cable gauges larger than 1.5 mm².

Connection examples

Wrong connection:

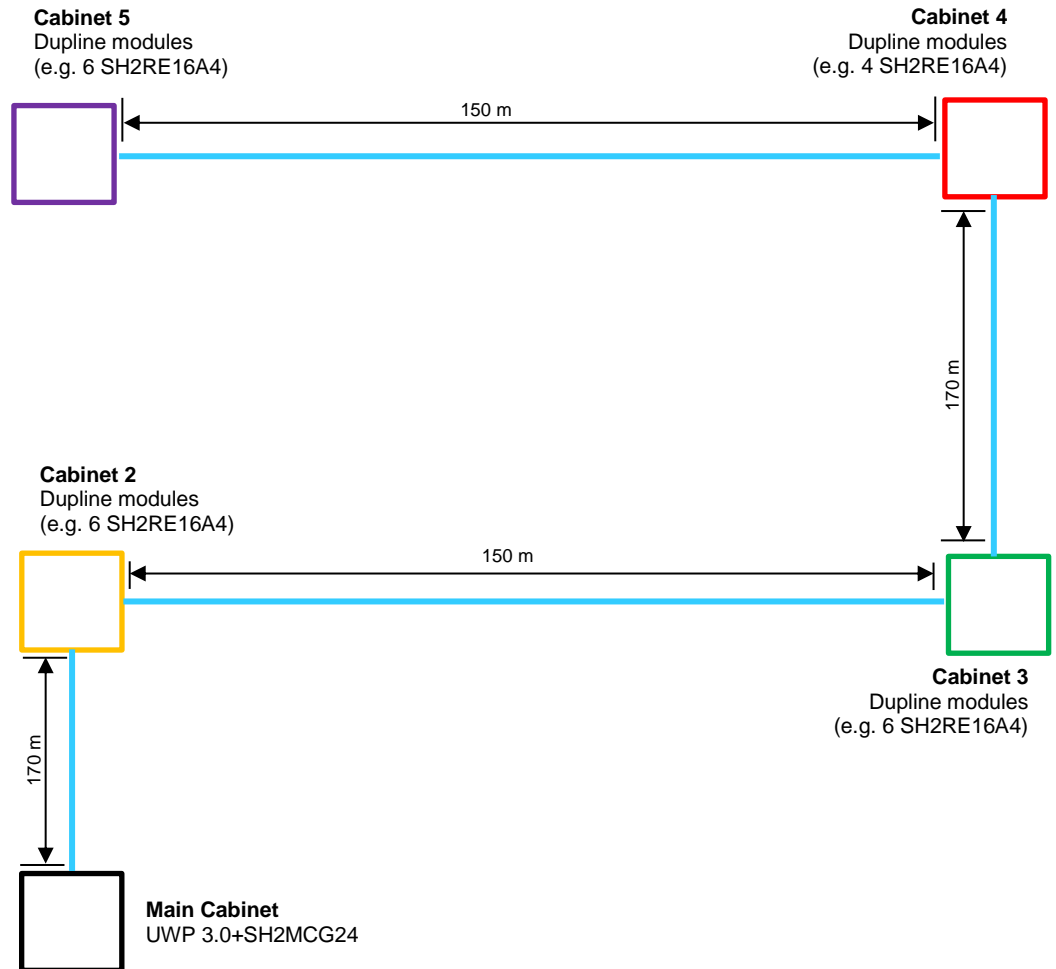

This network design is not recommended because the cable resistance and the load from bus-powered modules result in an excess of voltage drop.

Correct connection:

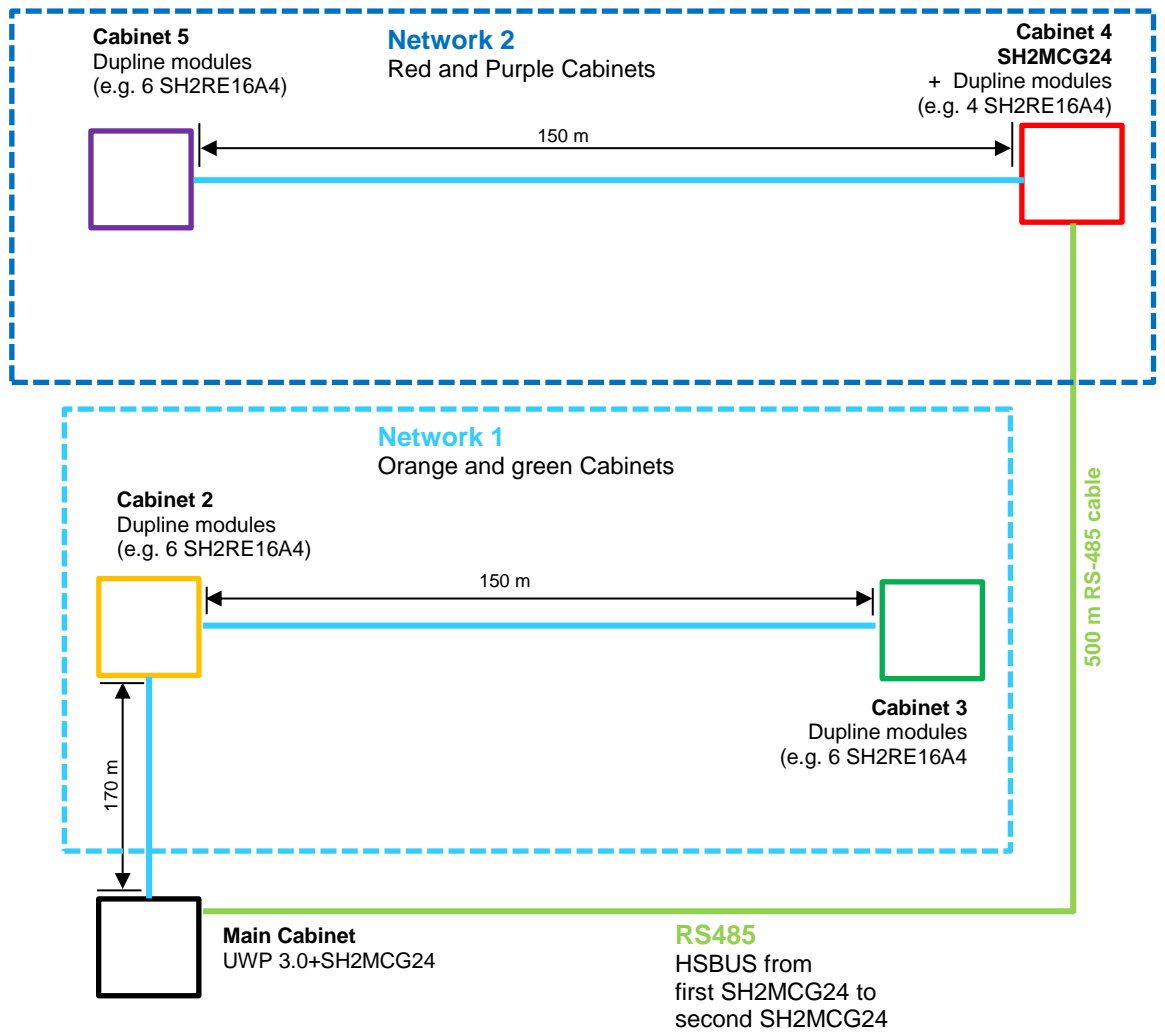

1.3.3 How to define the number of Dupline® networks

The building automation system is based on a proprietary protocol over the Dupline® bus that is called *SmartDupline®*.

Smart Dupline® implements a master-slave protocol running over standard Dupline® networks.

The concept of SmartDupline® is based on the SIN: it is a Specific Identification Number that is unique for each Dupline® module produced and it is written into the module during the production process and cannot be modified.

The SIN code is printed on the product label by applying this format:

SIN: 255.255.255

It contains information about the type of the Dupline® module (light switches, pir, I/O modules, ...), the firmware release and much more.

SmartDupline® enriches the previous protocol with these features:

- 1) By means of the Specific Identification Number the Master can program the network address ADD (1..250) in each device.
- 2) By means of the network address the Master can program the Dupline® standard channel addresses and all the other module parameters.
- 3) By means of the network address the Master can access all input and output module information.
- 4) In a single message frame it is possible to manage double word information.
- 5) A CRC control is implemented in request and reply frames. Should an error occur, the bus generator resends the request until it receives a correct frame.

Analogue data is transmitted via the SmartDupline® protocol without using digital I/O channels.

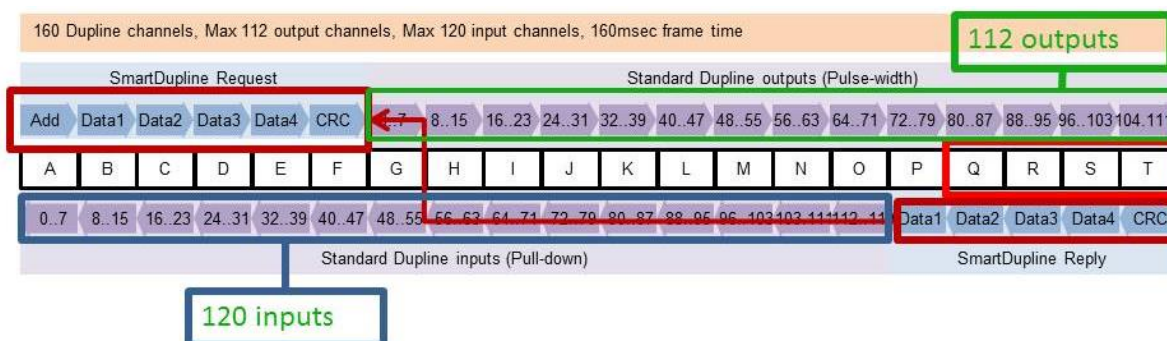

To calculate the number of **SH2MCG24** required, the following points have to be taken into consideration:

- 1) Each **SH2MCG24** can drive up to 250 Dupline® modules (as explained above, it can assign network addresses from 1 to 250).
- 2) Each **SH2MCG24** can manage up to 112 output signals (e.g. output relays, LEDs, dimmer...)
- 3) Each **SH2MCG24** can manage up to 120 input signals (light switches, digital input...)
- 4) Since most of the Dupline® slave modules are powered by the bus, the **SH2MCG24** provides it with a maximum output current of 450mA (at temperature 30°C), the lower is the current the higher is the life time of all the system.

The installer will have to calculate the sum of the required modules and their consumption in terms of current and input/output signals: when one of the four limits mentioned above is surpassed, a new Dupline® network (i.e. a new **SH2MCG24**) has to be added.

We suggest designing the Dupline® networks in the best possible way by dividing them according to specific areas (for example floors) and not to use the bus at its maximum load in order to have space for further expansion and to increase its life.

The consumption of input/output signals and current of every slave Dupline® module is given in the relevant datasheet.

Current consumption: in the datasheet/instruction manual this is always given in the *Dupline® Specifications* of each module.

Dupline® Specifications

Voltage	8.2 V
Maximum Dupline® voltage	10 V
Minimum Dupline® voltage	5.5 V
Maximum Dupline® current	2 mA

Dupline® channel consumption: in the datasheet/instruction manual this is always given in the *Mode of Operation* section under *Coding/Addressing*.

Mode of Operation

Coding/Addressing

If the light switch module is connected to the SH2WEB24 controller, no addressing is needed since the module is provided with a specific identification number (SIN): the user has only to insert the SIN in the SH tool when creating the system configuration.

Used channels: 4 input channels, 4 output channels.

1.3.4 Dupline® bus in the cabinet

Thanks to the local bus concept, the DIN-rail slave modules (dimmers, relays, roller blind modules, etc...) can just be plugged into the **SH2MCG24**, without the need for any wiring. The decentralized modules, such as light switches, PIR sensors, temperature display, are connected to the **SH2MCG24** by the two wires coming from the terminals at the top.

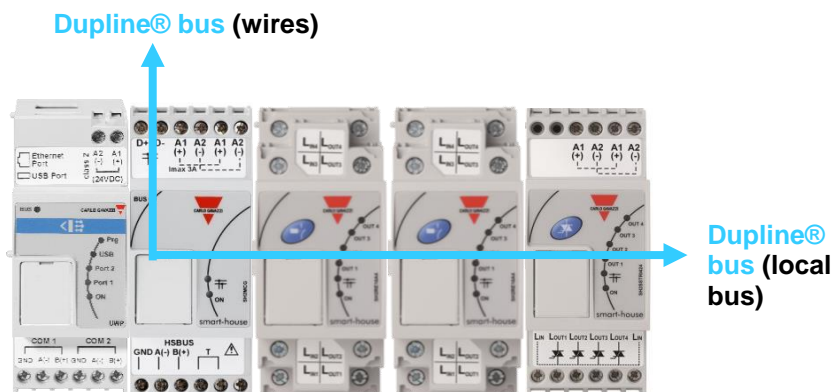

If more bus generators are connected in a DIN rail, they do not need to be plugged next to one other and they can also be mixed with the Dupline® I/O modules. The only rule that the installer has to take into account is that a Dupline® I/O module is connected to the Dupline® network generated by the last **SH2MCG24** at its left. See picture below.

Example 1:

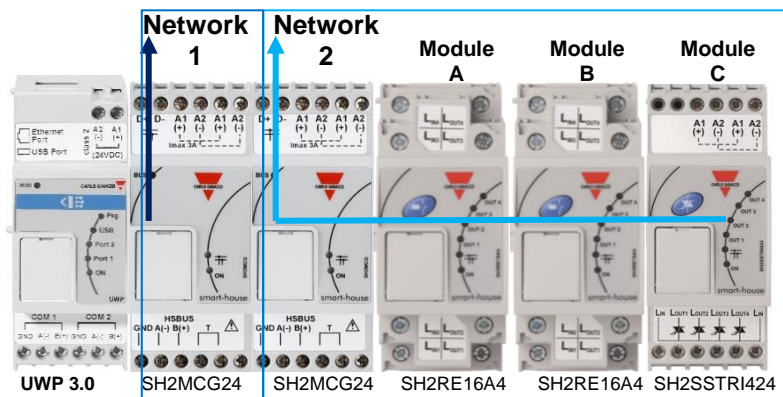

Modules **A**, **B**, and **C** are connected to the Dupline® network 2.

Example 2:

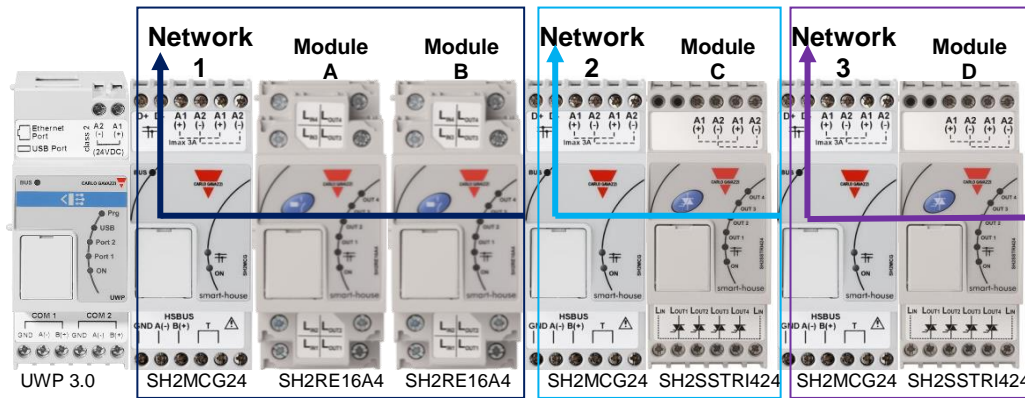

- Modules **A** and **B** are connected to the Dupline® network 1.
- Module **C** is connected to the Dupline® network 2.
- Module **D** is connected to the Dupline® network 3.

Since there are no Dupline® terminals on the top of the slave modules, to connect the Dupline® bus between different rails in a cabinet, the Dupline® transparent module SH1DUPFT has to be used. The SH1DUPFT simplifies the wiring of a building automation installation: it has to be connected at the beginning of a rail row bringing the Dupline® bus from the top and bottom connectors to the internal bus and vice versa. Internally, the three connectors are short-circuited. This means that the buses connected to the top and bottom connectors must be in the same Dupline® network.

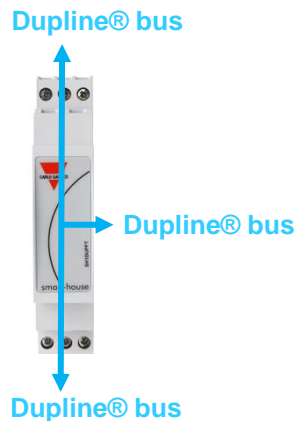

Example 3:

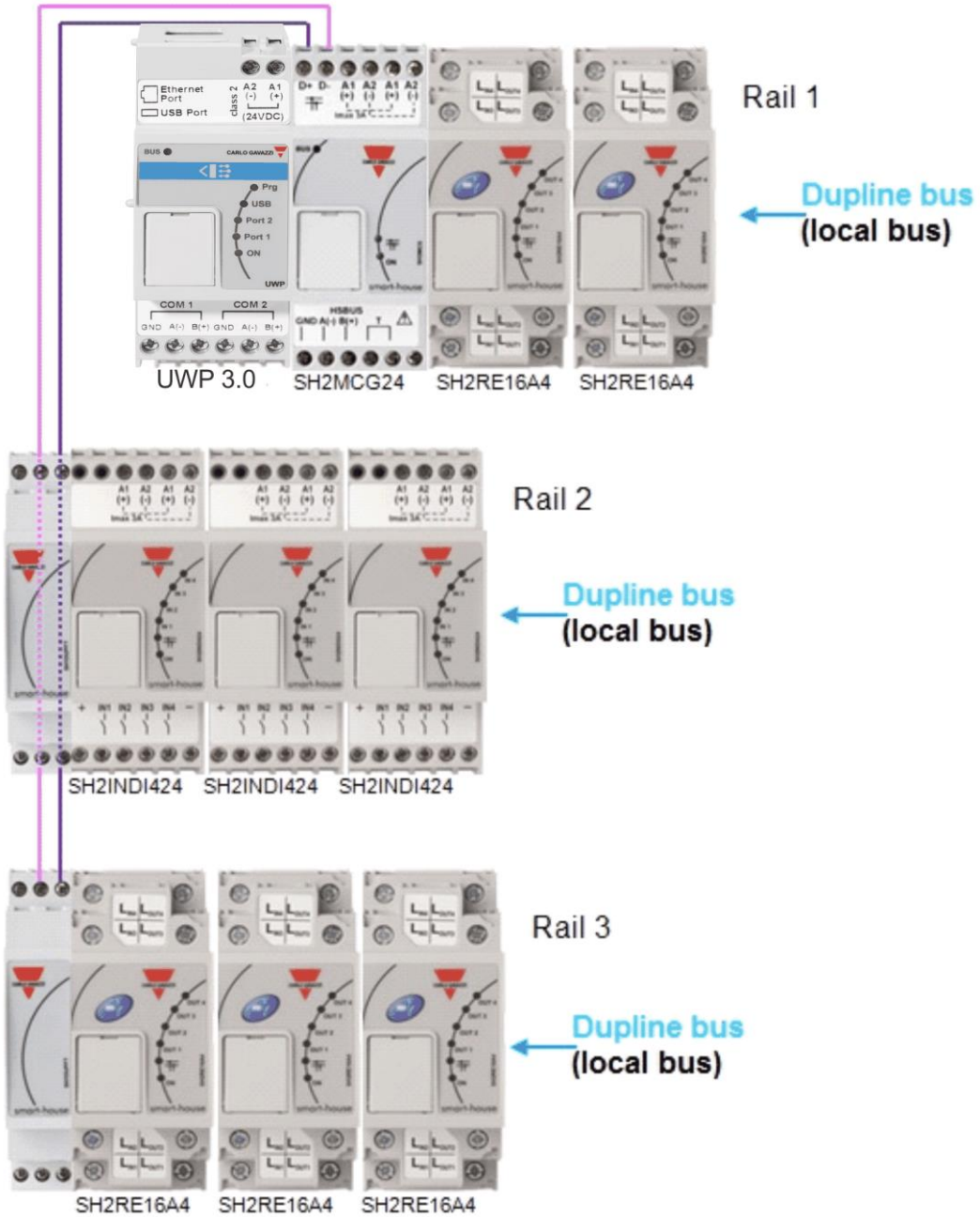

Recommendations:

Do not connect one SH1DUPFT to two Dupline® networks, otherwise the two buses will be short-circuited: the situation below must be avoided.

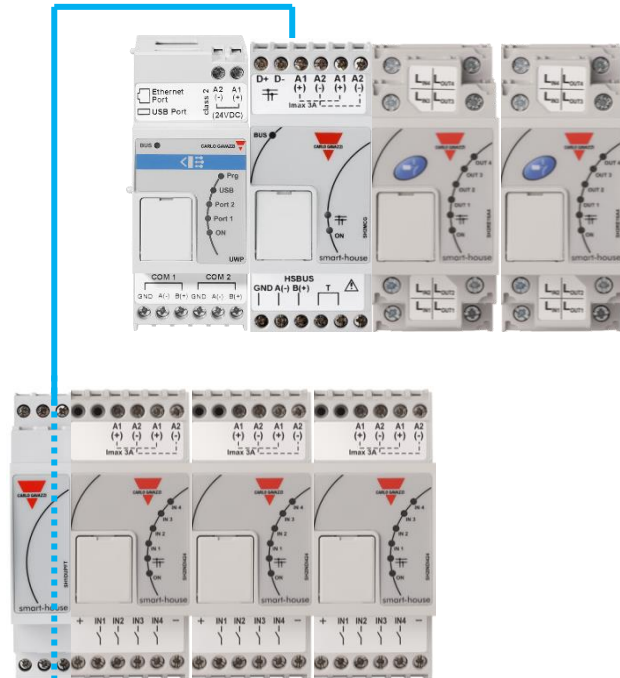

X This connection must be avoided otherwise two Dupline® networks will be short circuited. If this should happen, the system will not be damaged since the bus is protected, but it will not work properly.

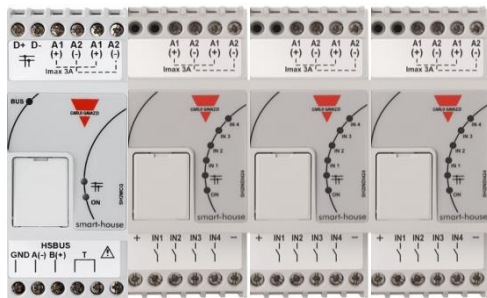

1.4 The wireless bus WiDup

Please see the manual *How to install the smart-building wireless system*.

1.5 How to connect the Mobile modem

The USB Dongle Connection Module SH2DSP24 has to be connected to the **UWP 3.0** through the auxiliary bus on the left side of the **UWP 3.0**. The modem can be used to send/receive messages or to access the Internet when the Ethernet LAN connection is not available.

The modem is configured by means of the **UWP 3.0 Tool** software: the user has to define the modem brand/model, the connection parameters, the phone numbers from/to which it has to receive/send the messages, the type of connection required (Data connection always active, Data connection if LAN not available, Only LAN).

How to install an UWP 3.0 system

1.5.1 How to connect the USB Dongle Connection Module SH2DSP24

The SH2DSP24 is a **UWP 3.0** accessory module that provides a reliable and cost-effective way to connect to the Internet by using mobile networks via an USB dongle modem.

The installer has to carry out the following procedure:

1. Connect the SH2DSP24 to the left of the **UWP 3.0** controller;
2. Insert the SIM into the dongle USB modem (*) through the SIM slot. Make sure the **SIM is not protected by a PIN code** (should that be the case, disable the protection). Please refer to the user manual of the model/manufacturer;
3. Insert the USB modem into the USB port located on the top of the SH2DSP24 module;
4. Connect the 24VDC power supply;
5. Configure it by means of the **UWP 3.0 Tool** software.

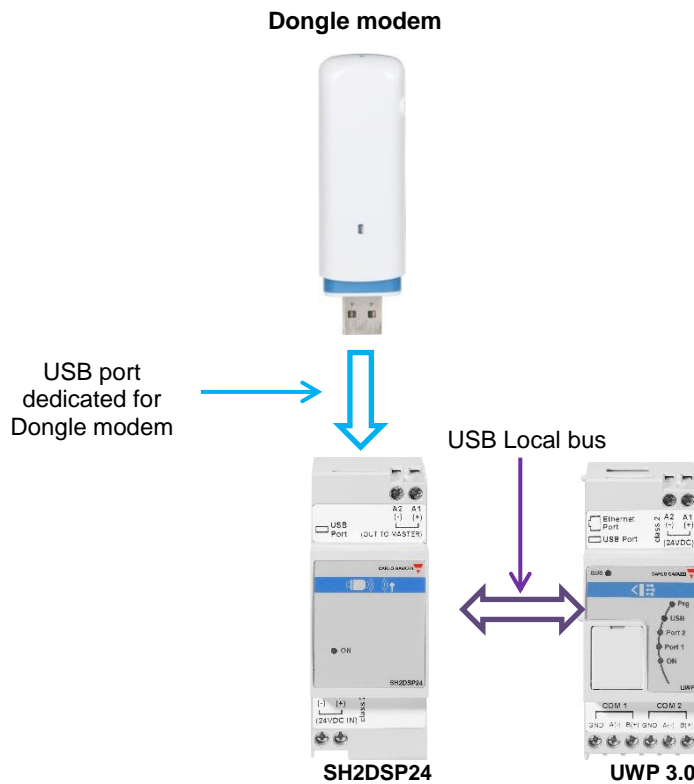

(*) The table below shows the compatible USB modems:

Manufacturer	Model	Type
HUAWEI	MS2131	3G modem
HUAWEI	E3531	
D-LINK	DWM 157 (Fw. 2 or 3)	
Multitech QuickCarrier®	USB-D	

Recommendation:

Place the modem where there is good signal strength: this can be checked by connecting to the **UWP 3.0 Tool**: at the bottom of the user interface there are 5 bars that indicate the field strength, as shown in the picture below.

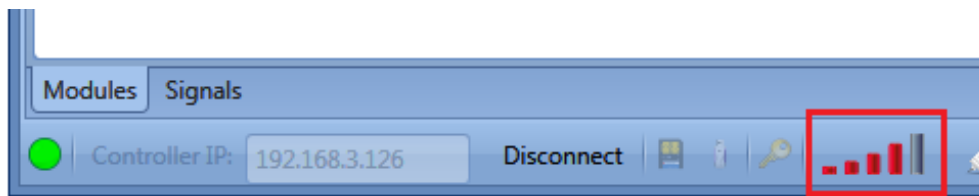

N.B. Since the USB bus used by the dongle modem is the same as the one used by the USB port on the top of the UWP 3.0, the latter cannot be used if the modem is already connected.

1.6 Ethernet connection

The Ethernet port is used to provide at the same time:

- a) field bus connection to TCP/IP based buses (Modbus/TCP, Bacnet)
- b) LAN/WAN connection to use the **UWP 3.0** through the automation server, web-server access, UWP 3.0 Tool

The **UWP 3.0** is configured by using the **UWP 3.0 Tool**, which has to be connected via the LAN port on the top of the **UWP 3.0**.

When connecting the network cable, the Ethernet port LEDS will also light up.

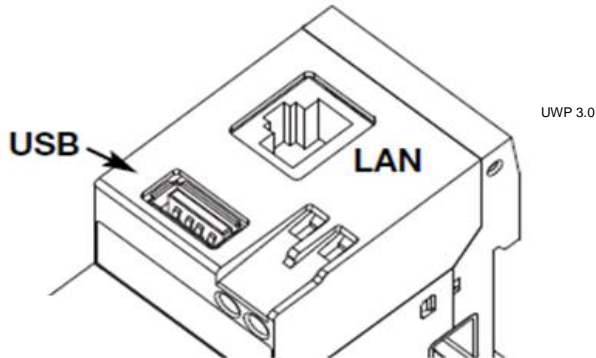

To configure the IP address, please refer to the **UWP 3.0 Tool** software manual.

The LAN connection can be used to connect the **UWP 3.0** to an Ethernet network when it has to be connected to other devices over TCP/IP such as the BTM-Tx-24 display.



The TCP/IP device can be connected directly to the **UWP 3.0** with a peer to peer connection by using fixed IP (see the **UWP 3.0 Tool** manual to configure a fixed IP).



The TCP/IP devices can be connected to the **UWP 3.0** via a router by using both DHCP addressing or fixed IP with NAT forwarding if the **UWP 3.0** is to be visualised via the Internet.

1.7 Micro SD

The IP address of **UWP 3.0** can be changed by using a “Micro SD” or “SDHC” memory card correctly inserted into the relevant slot (see **UWP 3.0 Tool** software manual for the relevant details).

N.B: the maximum capacity of the Micro SD card is 16GB.

1. Open the flap located on the **UWP 3.0** front panel. Identify the slot specifically designed for the insertion of the “Micro SD” memory card.

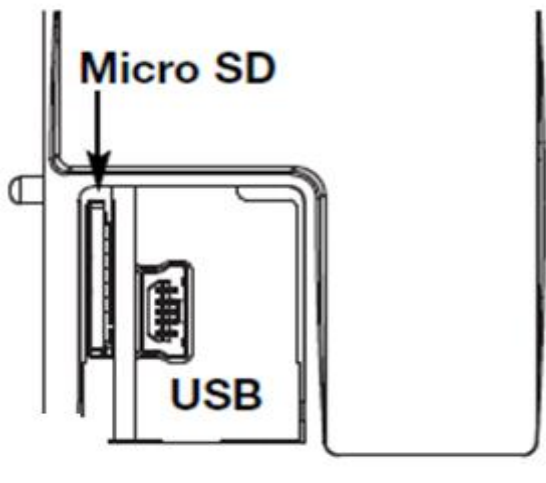

2. Insert the Micro SD card, making sure it is not write-protected and it is correctly formatted (FAT32).
3. Close the flap. Warning: if the flap is not properly closed **UWP 3.0** will not enable any writing or reading operation (flap closing is verified by a micro switch located under the flap).
4. As soon as the flap is closed, **UWP 3.0** will install the newly inserted memory card and update the IP address. Warning: opening the flap during the writing stage will stop the data transfer process and may potentially damage the Micro SD memory.

1.8 USB stick installation

The IP address can be changed by using a USB stick (or Pen drive). For the relevant details please read the UWP 3.0 Tool manual.

1. Identify the USB port specifically designed for the insertion of the Pen drive memory.

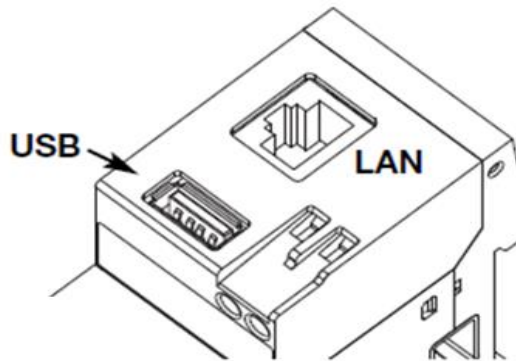

2. Insert the Pen-drive, making sure it is not write-protected and it is correctly formatted (FAT32).
3. As soon as you have inserted the Pen-drive, **UWP 3.0** will install the newly inserted memory and update the IP address. While the installation and writing operations are under way, the front “USB” LED (blue) will blink. Warning: disconnecting the Pen-drive during the writing stage will stop the data transfer process.

1.9 How to size the Carlo Gavazzi DC power supply

The Building Automation system is powered by 24 Vdc nominal (15-30 Vdc)

Since most of the Decentral Dupline® slave modules are powered by the bus, the sizing of the power supply has to be based on the DIN-rail modules, and among these only the ones powered by 15 to 30 Vdc: the power dimmers and the relay output modules that switch 230 Ac load are powered by 230Vac.

In the table below, the list of devices is given, with the relevant power consumption that has to be considered in the sizing of the power supply.

Item number	Description	Operational power
UWP 3.0	Master unit	5.0 W
SH2MCG24	Bus generator	6.5 W
SH2RODC224	Roller blind module for DC motor	3.0 W
SH2ROAC224	Roller blind module for AC motor	3.0 W
SH2INDI424	Digital input module	0.4 W
SH2SSTRI424	Solid state relay output module	0.4W
SH2D10V424	1 to 10V dimmer	0.4 W
SH2UMMF124	Universal mobile modem	5.0 W

The suggested families are: SPDT24xx, SPM3241, SPM4241, SPM5 and SPM5B (battery charger). According to the power required, the right models has to be selected.

1.9.1 How to calculate the needed power

To calculate the required power, the sum of the consumption of all the Din-rail modules has to be calculated.

For example, if in an installation the following modules are present, the total consumption has to be calculated following the column *Consumption* in the table below:

Item number	Quantity	Consumption
UWP 3.0	1	1x 5.0 = 5.00 W
SH2MCG24	2	2x 6.5 = 13.0 W
SH2RODC224	0	
SH2ROAC224	4	4x 3.0 = 12.0 W
SH2INDI424	2	2x 0.4 = 0.80 W
SH2SSTRI424	0	
SH2D10V424	5	5x 0.4 = 2.00 W
SH2UMMF124	1	1x 5.0 = 5.00 W
	Total needed power	37.80 W

In this case a power supply delivering 40W is the right solution.

1.9.2 How to wire the power supply

The DIN-rail modules powered by to 24 Vdc nominal (15-30 Vdc) come with in/out connections to speed up wiring: there are two A1(+) terminals that are internally short circuited, and two A2(-) terminals that are also short circuited.

The best wiring should be carried out as shown below. The immunity to EMC can be improved by connecting the negative terminal of the DC power supply of the system (-) to the earth ground.

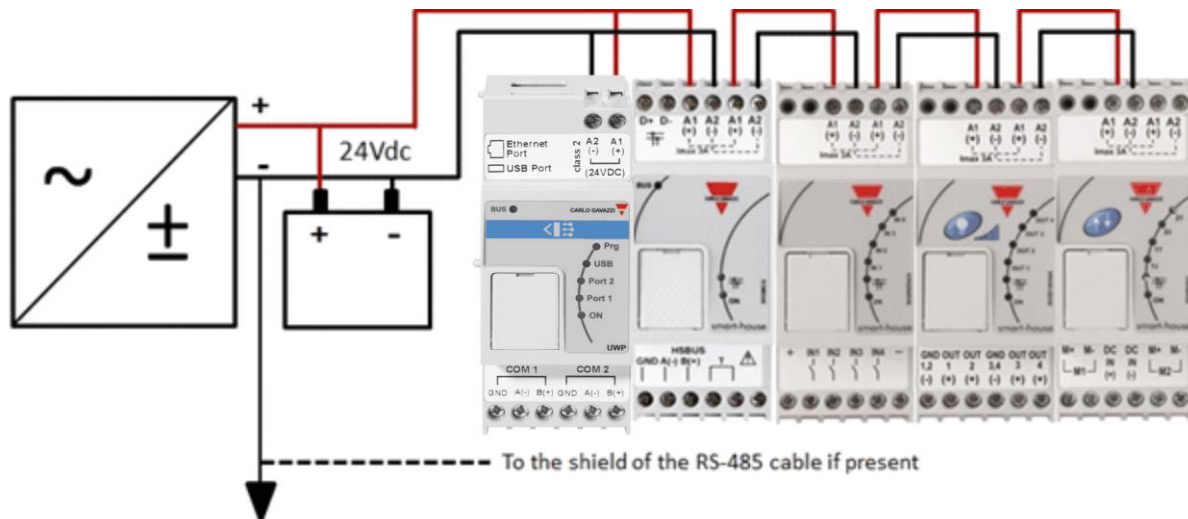

All the DIN-rail modules with the in/out terminals come with two short wires already screwed into the A1 and A2 terminals in order to speed up commissioning.

Recommendations:

- 1) Use a battery back-up system to avoid switching off the installation if a power down should occur.
- 2) Be careful to have a total current not greater than 3A on the power supply if using the in/out terminals, since the maximum current that the internal connections can withstand is 3A.
If Dc motors are used to control roller blinds or windows, do not supply them from the same wires used in the in/out connections since the maximum current they can withstand is 3A (see below: in this case the sizing of the power supply must take into consideration also the consumption of the motor).
- 3) It is recommended that the system is supplied @24Vdc in order to reduce the current and thus the stress on the internal electronic components. This will result in a longer lifetime of the modules.

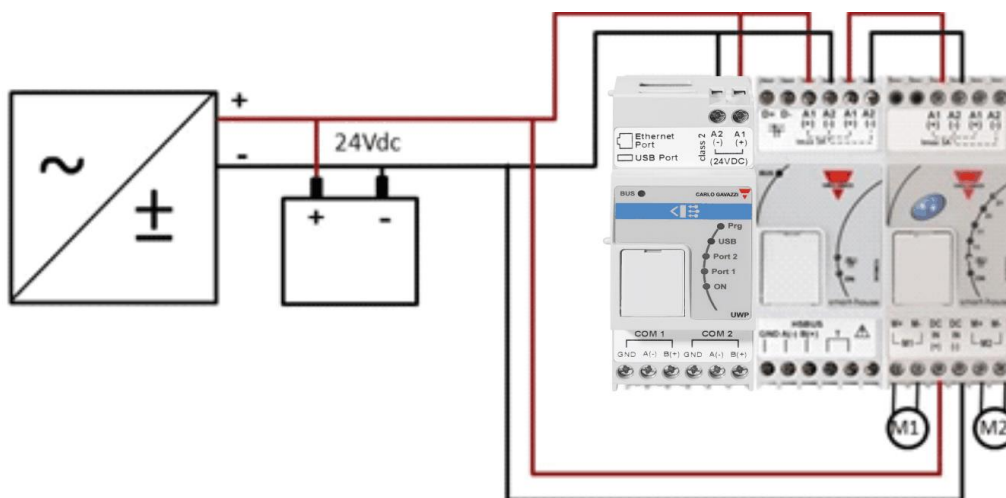

2 Installing the Building Automation system

The installer has to perform the following steps to install a smart-building system:

1. Define the required Building Automation functions and the relevant modules
2. Define the number of necessary bus generators, following the suggestion described in the paragraph: *How to define the number of Dupline® networks*
3. Size the 24 Vdc power supply as described in the paragraph: *How to size Carlo Gavazzi DC power supply*
4. Install the Dupline® bus, following the suggestion given in paragraph *The Dupline® bus*
5. Position and design the cabinet(s) correctly, following the suggestion given in the description of the Dupline® bus and the HSbus.
6. If the modem is part of the installation, it has to be placed to the left of the **UWP 3.0**
7. The DIN-rail module has to be placed as described in the Dupline® a HSbus paragraphs
8. Connect the loads and inputs/outputs as described in the relevant datasheets of the DIN-rail modules (ON/OFF light, dimmable light, blind motors, ...)
9. Connect the energy meters to the serial port COM 2 and configure them (modbus address, baud rate,...)
10. Connect the LAN via the Ethernet connector
11. Connect the power supply: 24Vdc and 230Vac

When switching on the **UWP 3.0**, the following LEDs will light up on the front panel: green “ON” LED (indicating the device is powered), yellow “BUS” LED (indicating HSbus activity), yellow COM2 LED (indicating COM door activity), blue “USB” LED (indicating the presence of a USB device) and red Status LED (at the first start-up it will be ON, indicating that no configuration is present or when it is connected to a PC via the **UWP 3.0 Tool**). When connecting the network cable, the Ethernet port LEDs will also light up.

When switching on the **UWP 3.0**, the following LEDs will light up on the front panel: green “ON” LED (indicating the device is powered), yellow “BUS” LED (indicating HSbus activity), yellow Dupline® LED (indicating Dupline® bus activity).

When switching on the SH2UMMF124, the following LEDs will light up on the front panel:

- Green LED: ON (indicating the machine is powered)
- Blue LED: *fast blinking*: searching for the cover signal / not registered / switching off.
slow blinking: service is registered and signal is available.
steadily on: communication under way.

When switching on the SH2DSP24, the green LED will be lit up, indicating the module is powered. See the LED/LEDs on the dongle USB modem for any network information.

When switching ON the other DIN-rail I/O modules, the following LEDs will light up on the front panel: green “ON” LED (indicating the device is powered), yellow “ON” Dupline® LED (indicating Dupline® bus activity), red I/O LEDs (indicating the relevant input/output status).

After connecting and powering the **UWP 3.0**, connect it to the **UWP 3.0 Tool**, following the instructions in the **UWP 3.0 Tool** manual.

The **UWP 3.0** IP settings are factory-configured to start as DHCP. If no routers are present, please change the IP address as described in the **UWP 3.0 Tool** manual, by using the USB key.

To create a configuration, please follow the instructions in the **UWP 3.0 Tool** manual.

3 Appendix “A” – RS485 network guidelines

3.1 MODBUS via Serial line (RS-485) guidelines

3.1.1 Introduction

The RS-485 is a half-duplex multidrop network: multiple transmitters and receivers may share the same line, but only one transmitter may be active at any given time. The TIA/EIA-485-A says nothing about the communication protocol to be used.

The MODBUS standard defines an application layer messaging protocol. The MODBUS Serial Line is a master-slave protocol which may use the RS-485 as its physical interface.

3.1.2 RS-485 cable

The suggested cable is the shielded twisted for three wire connections. Cables must be at least 0,5mm². The typical cable impedance should be between 100 ohm and 120 ohm.

3.1.3 RS-485 grounding

Communication through a RS-485 system is made by means of a balanced pair with a common so a three wire connection is needed. The shield must be connected directly to earth ground, preferably at one point only for the entire RS-485 Bus. Generally this point should be chosen on the master device or on its tap and not shared with other devices (inverters,...) which could add external noise or disturbance.

3.1.4 RS-485 shielding

A shielded cable is required to guarantee a high degree of immunity to EMC and lightning events. The improvement of EMC immunity can also be done connecting the minus of the DC power supplier of the system (-) to the earth ground.

3.1.5 RS-485 termination

A termination is needed at each end of the bus. Termination must not be placed anywhere else. For the relevant termination please check the official documentation here: www.modbus.org/docs/Modbus_over_serial_line_V1.pdf

3.1.6 RS-485 wiring procedure

Suitable wire sleeves must be used for wiring. If any wire splice is to be used, this splice must be soldered, taking special care to cover the splice with a cable shield and to ensure proper continuity.

3.1.7 RS-485 topology

Due to signal reflection issues, topology is not free, but only certain configurations are allowed. The only configuration which guarantees sufficient reliability is the daisy-chain. The maximum length of a derivation is 1 metre.

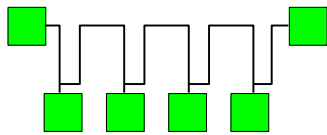

Daisy Chain (best)

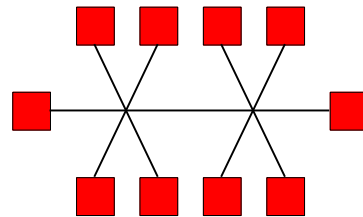

Backbone with stars or clusters (avoid)

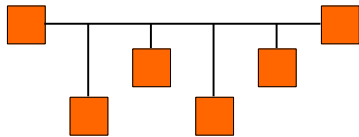

Backbone stubs (workable)

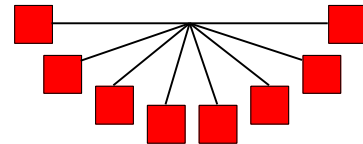

Stars network (avoid)

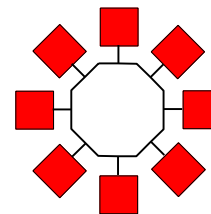





Ring (avoid)







4 Appendix B - Safety recommendations

This section contains important safety related information. If these recommendations are not strictly followed, serious damage may occur to devices or machinery and serious injury or death may occur to people. Please read this manual carefully before beginning any installation, maintenance or operational activity.

Safety recommendations to be followed when installing, operating and maintaining the equipment.

SAFETY RECOMMENDATIONS		The manufacturer denies any kind of direct or indirect responsibility for consequences resulting from the non-observance of the safety recommendations and from misuse of the equipment.
	UNAUTHORIZED PEOPLE MUST NOT TOUCH	The product contains electrical components constantly under voltage. Only skilled personnel correctly trained to operate on circuits constantly under voltage are allowed to open the cover of the device.
	DO NOT USE WATER TO PUT OUT FIRE	Water jets or jets of other liquids must not come in contact with the electric panel
	INSTALL AVOIDING DIRECT EXPOSURE TO SUNLIGHT	Direct exposure to sunlight may cause overheating even if the ambient temperature is in the requested range. Do not install the device near to heat sources.
	DO NOT CONNECT VOLTAGES EXCEEDING RATED VALUES	Do not connect supply voltages exceeding rated values to avoid damage to the equipment and potential risk of injury or death to operators
	DO NOT SHORT CIRCUIT TERMINALS	Do not short circuit terminals (+) and (-) to avoid damage to the equipment and injury or death to operators

SAFETY RECOMMENDATIONS		The manufacturer denies any kind of direct or indirect responsibility for consequences resulting from the non-observance of the safety recommendations and from misuse of the equipment.
	ELECTRICAL COMPONENTS CONSTANTLY UNDER HIGH VOLTAGE	
	DANGER !!! RISK OF DAMAGE AND INJURY AS A RESULT OF INCORRECT WIRING	Carefully check wiring. Incorrect wiring of the device terminals can cause irreversible damage to the equipment and injury to operators. Use cable lugs for any wiring cables.
	DANGER !!! RISK OF DAMAGE AND INJURY AS A RESULT OF INCORRECT GROUNDING	Carefully check grounding. The user must provide a grounding system in compliance with the regulations in force according to the electrical installation in use.
	DANGER !!! FIRE HAZARD IN THE PRESENCE OF INFLAMMABLE FUMES	There is a fire or explosion hazard if the device is installed in the presence of inflammable fumes. The device must not be installed in places exposed to explosion or fire hazard
	ALWAYS TIGHTEN SCREWS CORRECTLY	Always correctly tighten the fastening screws of the wiring terminals